

ASSEMBLY INSTRUCTIONS

DINING CHAIR MODEL#: UDC8025W

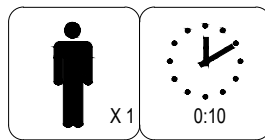
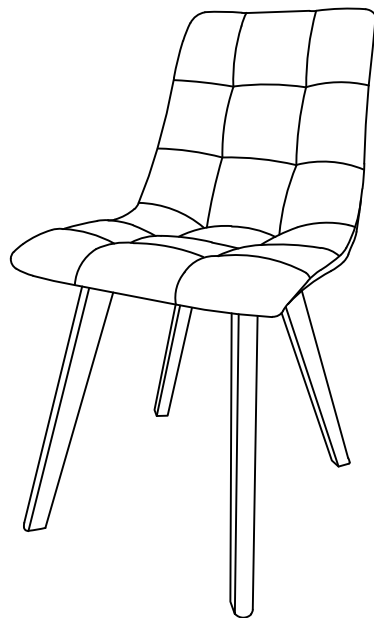
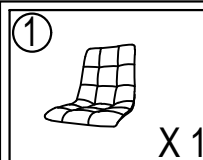
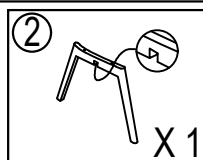
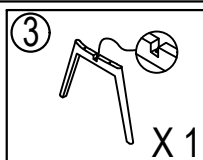
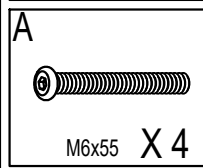
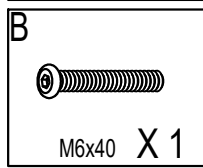
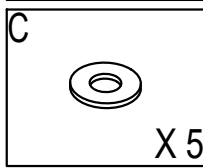
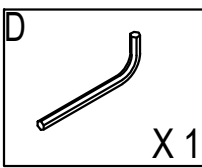

 X 1	 X 1	 X 1
 M6x55 X 4	 M6x40 X 1	 X 5
 X 1		

1

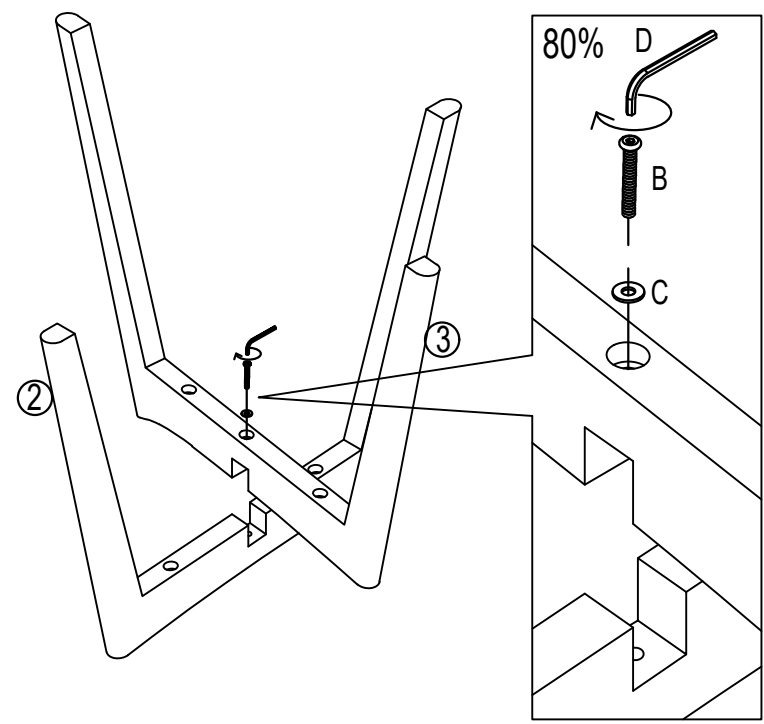

2

