







# 1 ASSEMBLY INSTRUCTION

- A  x1
- B  x2
- C  x2

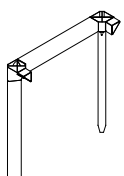
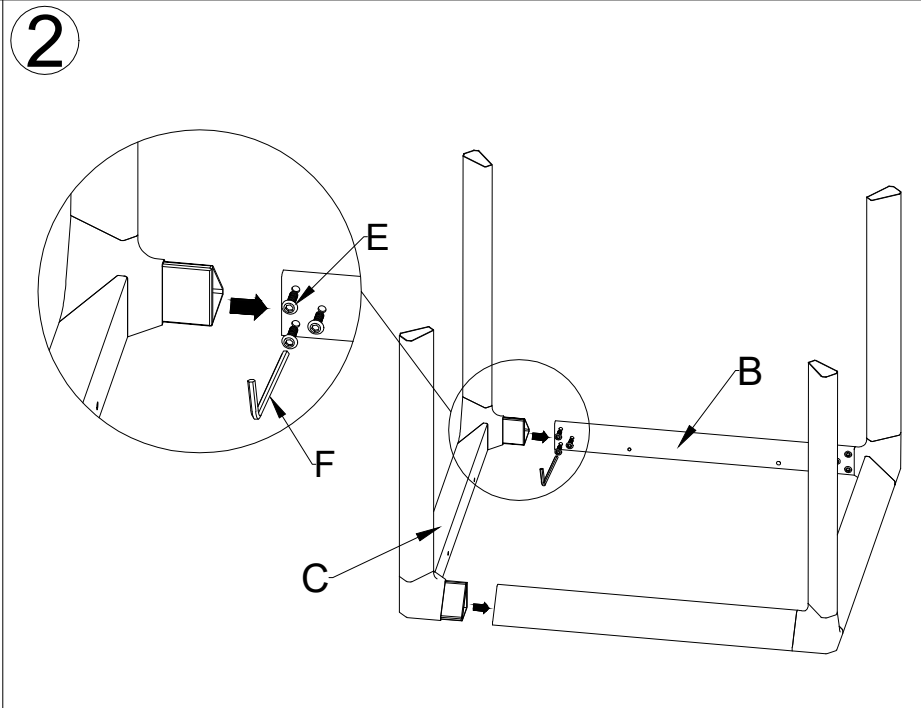
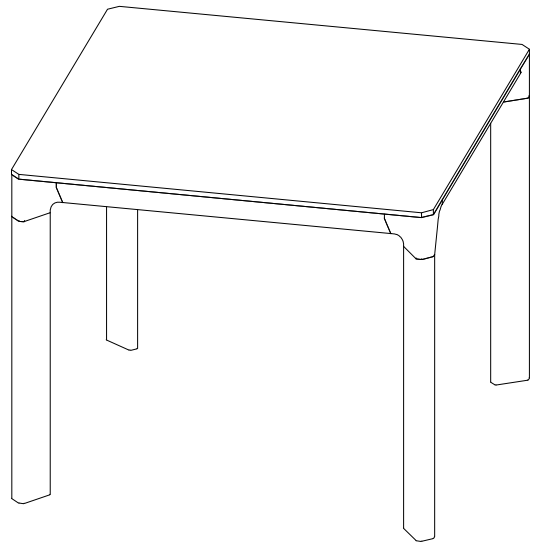

- D  x4
- E  x20
- F  x1

