

Katrine

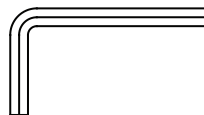

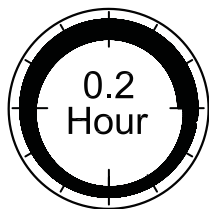

5/16" x 22mm
C x 4

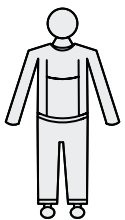
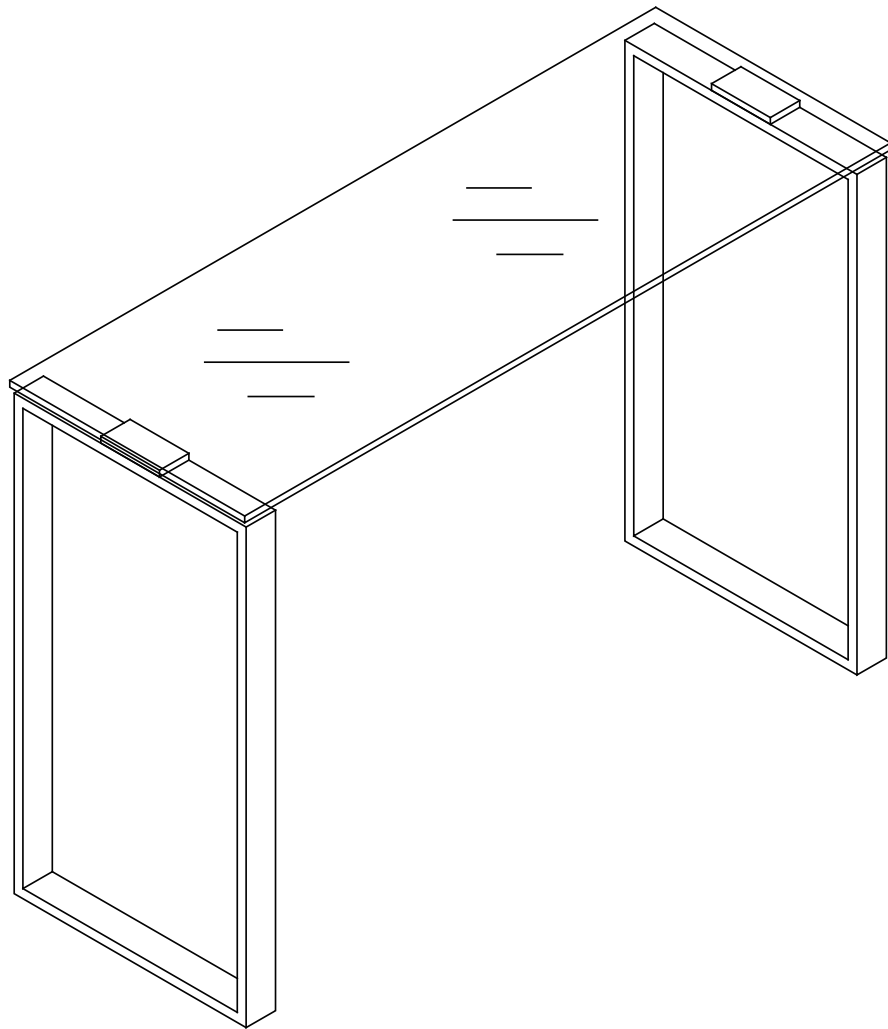
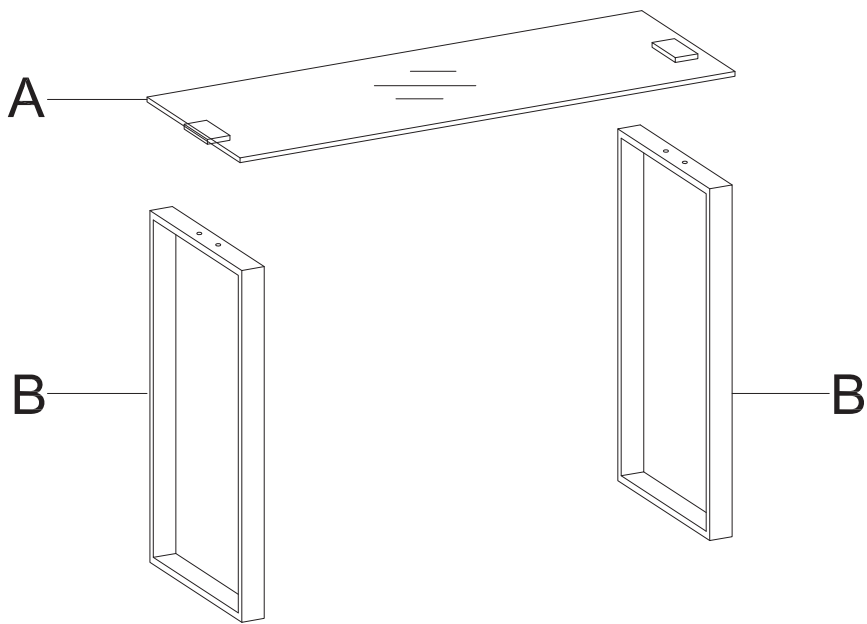

Ø16 x 2.0mm
D x 4



4mm
E x 1



Step 1

