

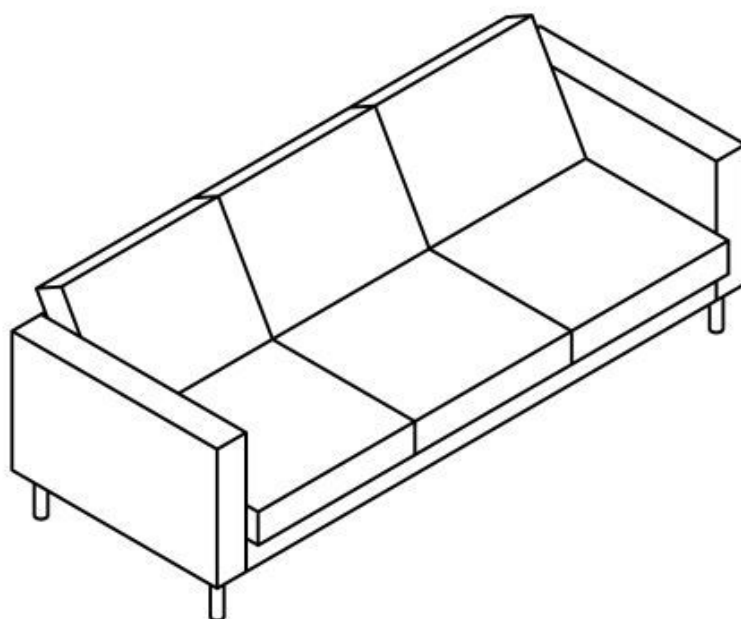

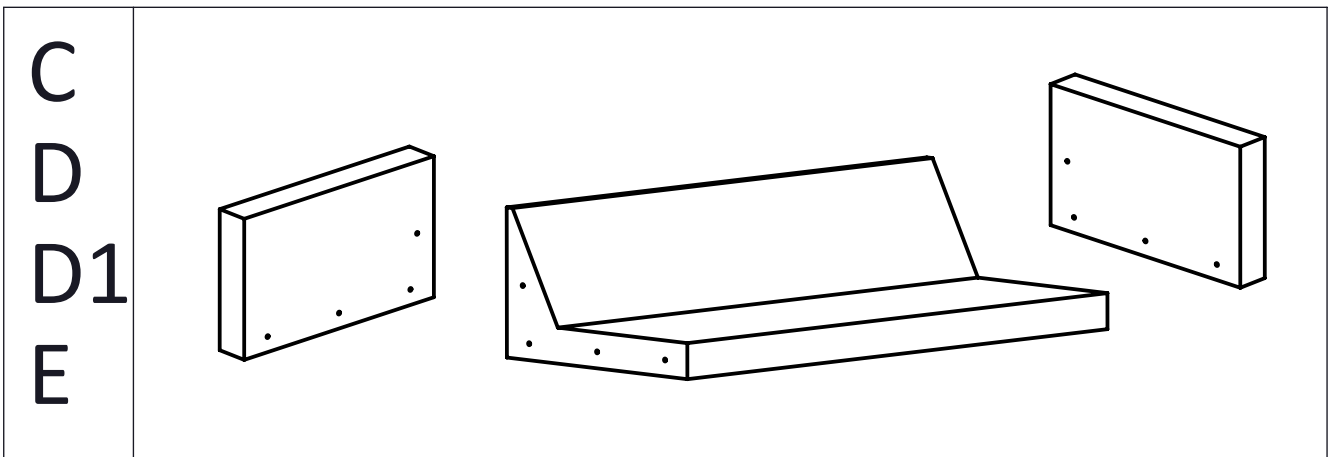

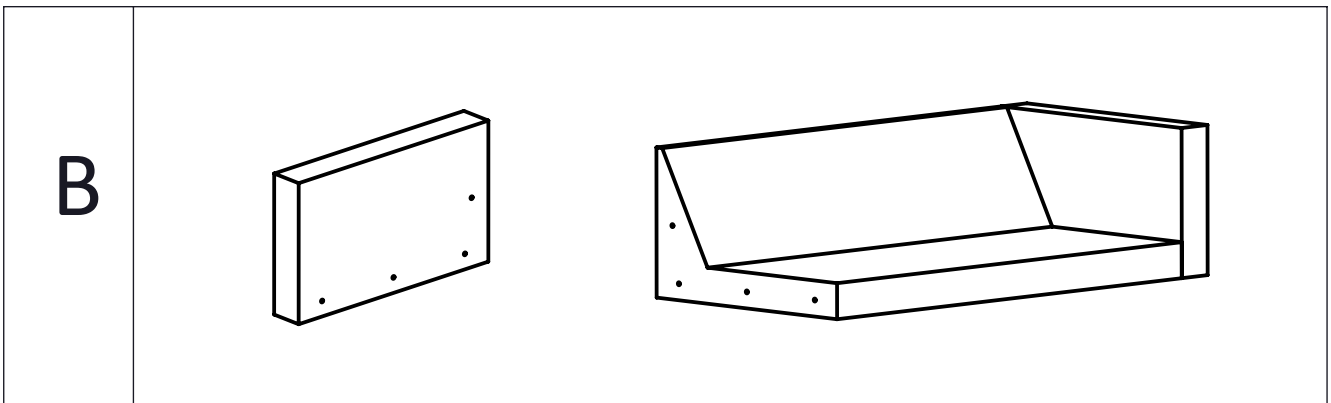

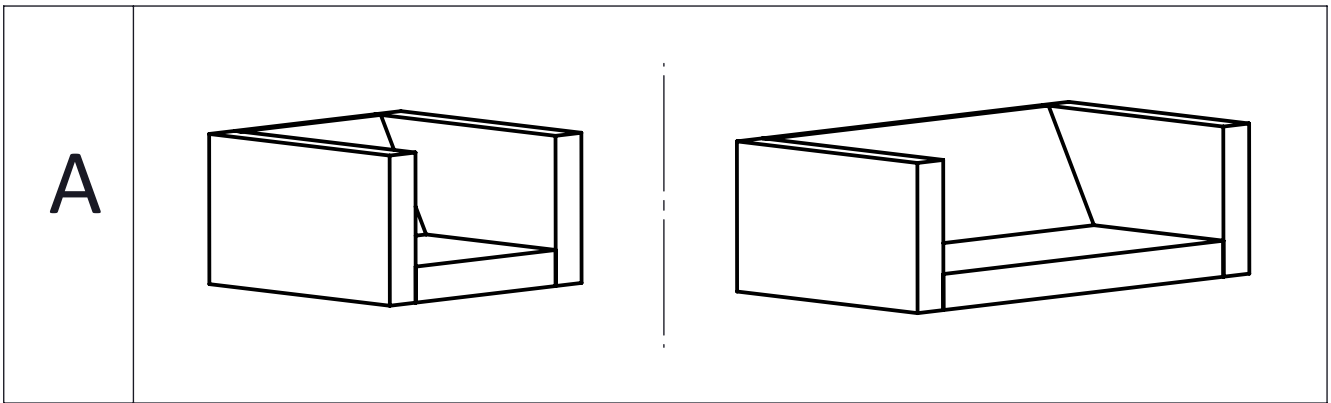
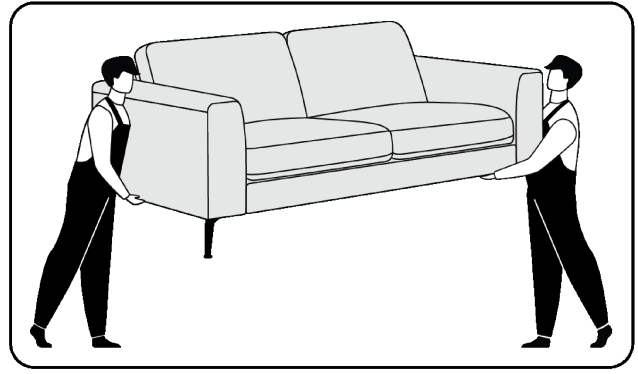
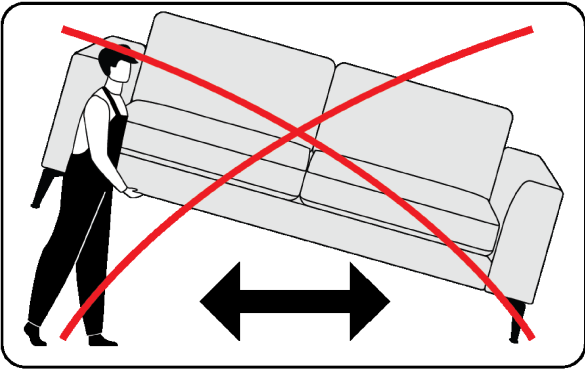
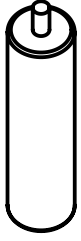
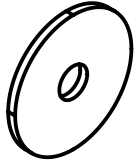

Kokkupanekujuhend Assembly instructions



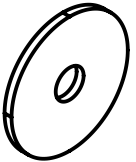



Diivan LANDO 3-kohaline, tumebeež (77859)
Sofa LANDO 3-seater, dark beige (77859)



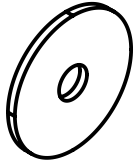









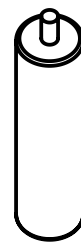
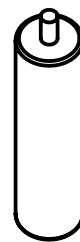

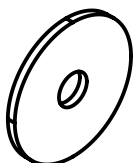



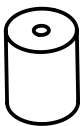

A	a x 4	b x 4	c x 4				
		 D50					

B	a x 4	b x 4	c x 4	d x 4	e x 4	f x 4	g x 1
		 D50		 M8x60	 M8	 M8	 13mm

C	a x 4	b x 4	c x 4	d x 8	e x 8	f x 8	g x 1
		 D50		 M8X60	 M8	 M8	 13mm

D1 $\frac{a2 \times 2}{c \times 6}$

D	a1 x 4	a2 x 1	c x 5	b x 4	d x 8	e x 8	f x 8	g x 1
		 EXTRA		 D50	 M8x60	 M8	 M8	 13mm

E	a1 x 4	a3 x 1	h x 1	b x 4	c x 5	d x 8	e x 8	f x 8	g x 1
		 EXTRA		 D50		 M8x60	 M8	 M8	 13mm

I

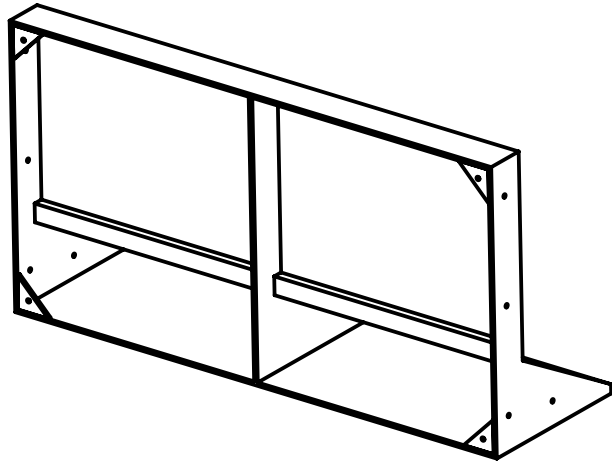

II

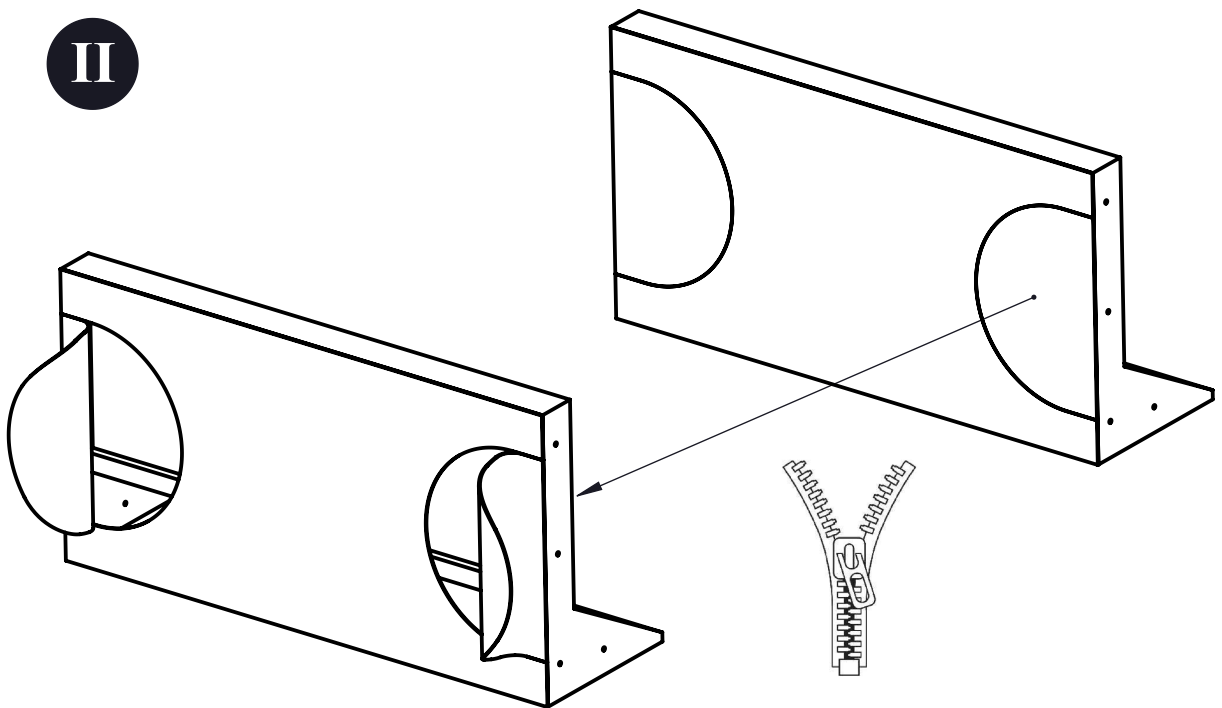

A

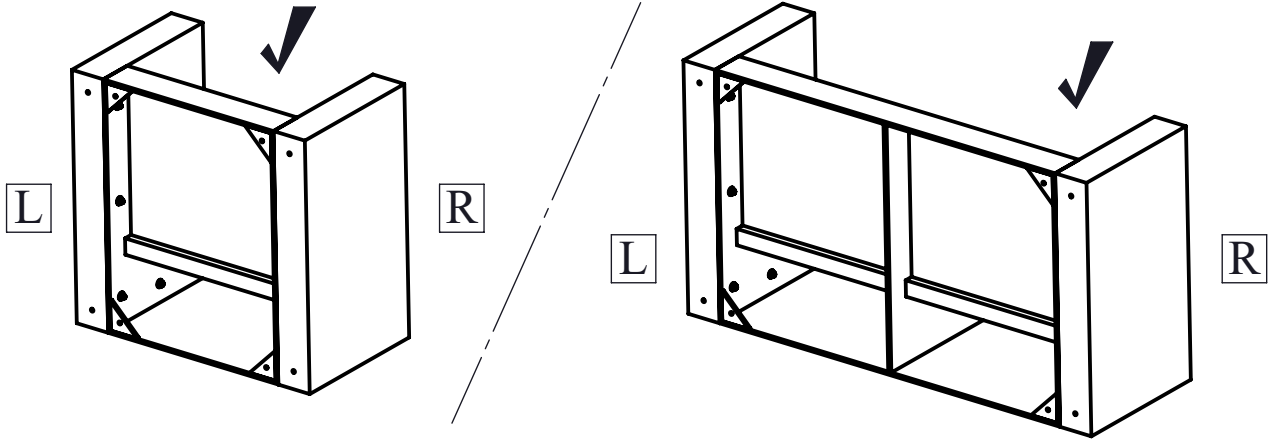

B

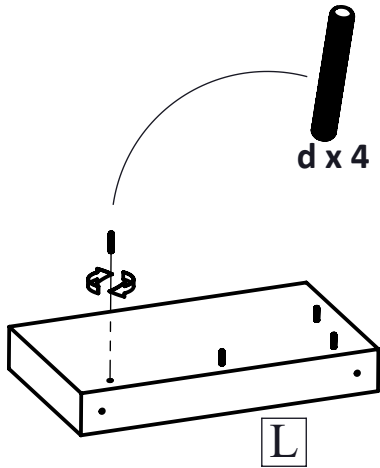

C

D

E

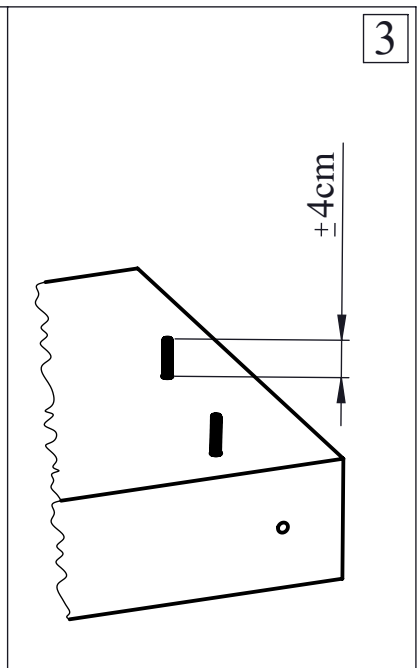
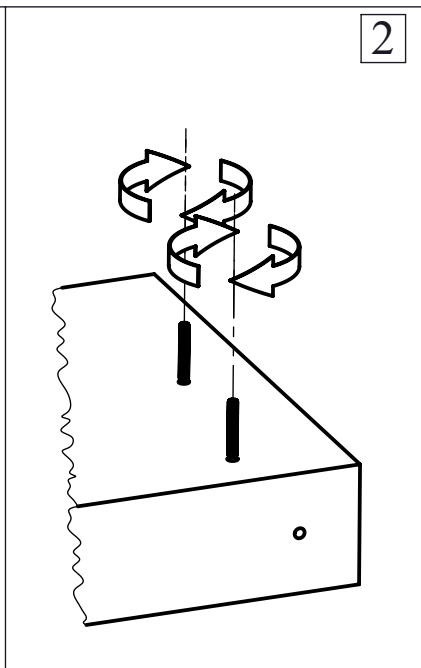
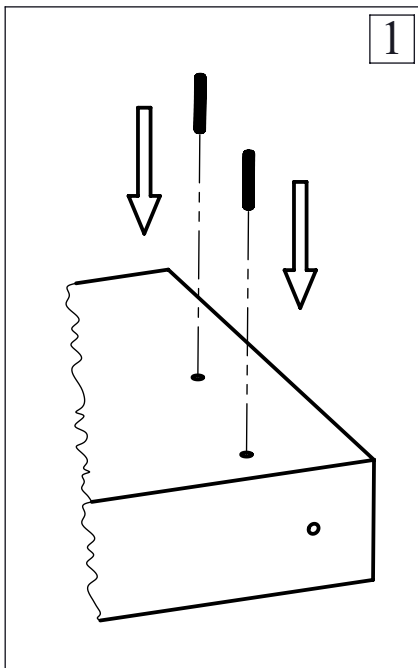
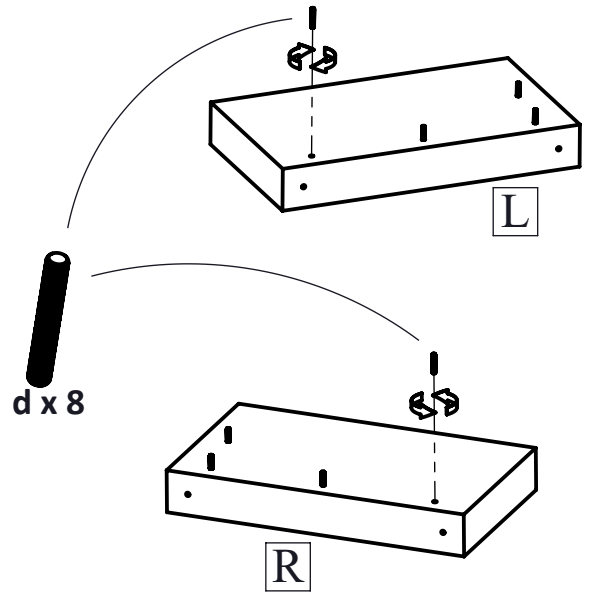

B

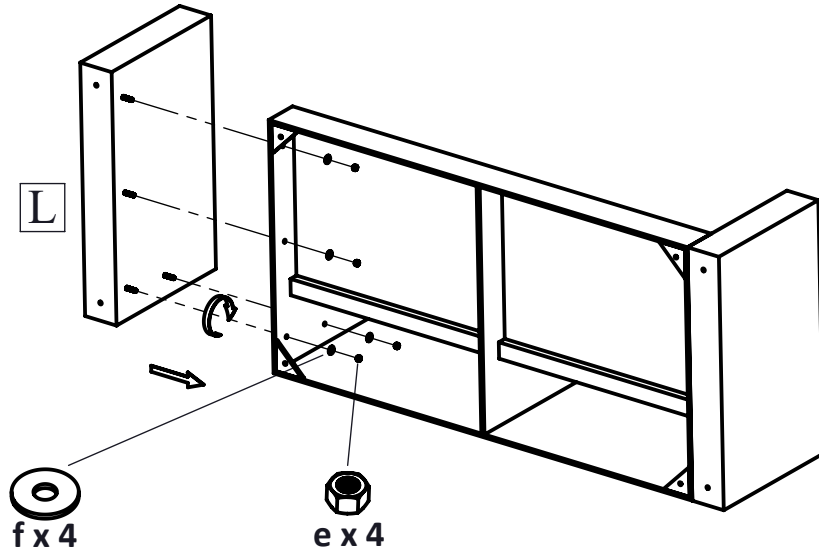

C D E

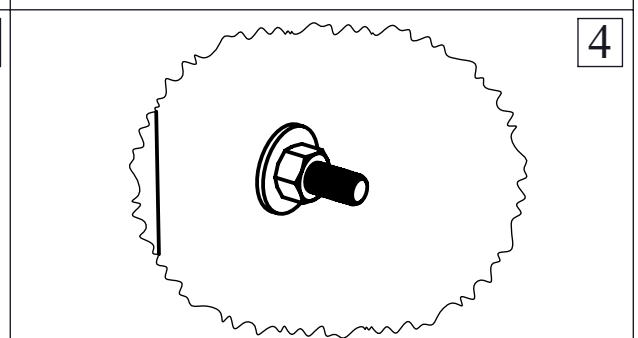
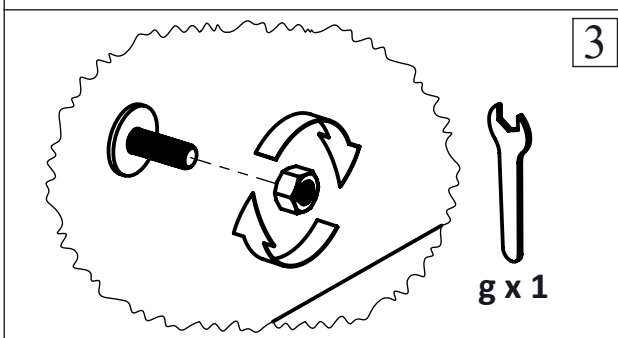
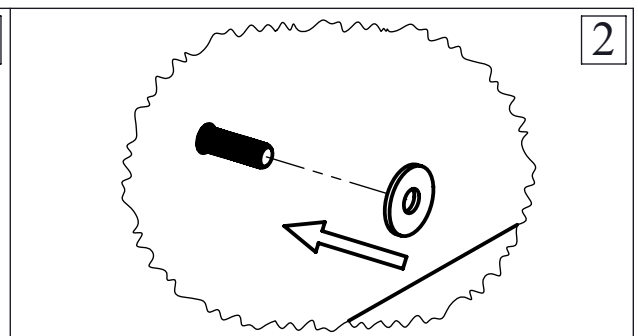
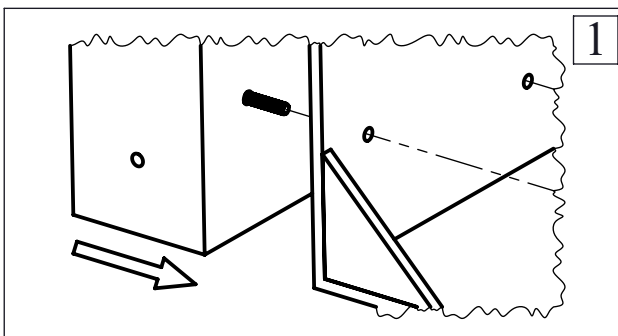
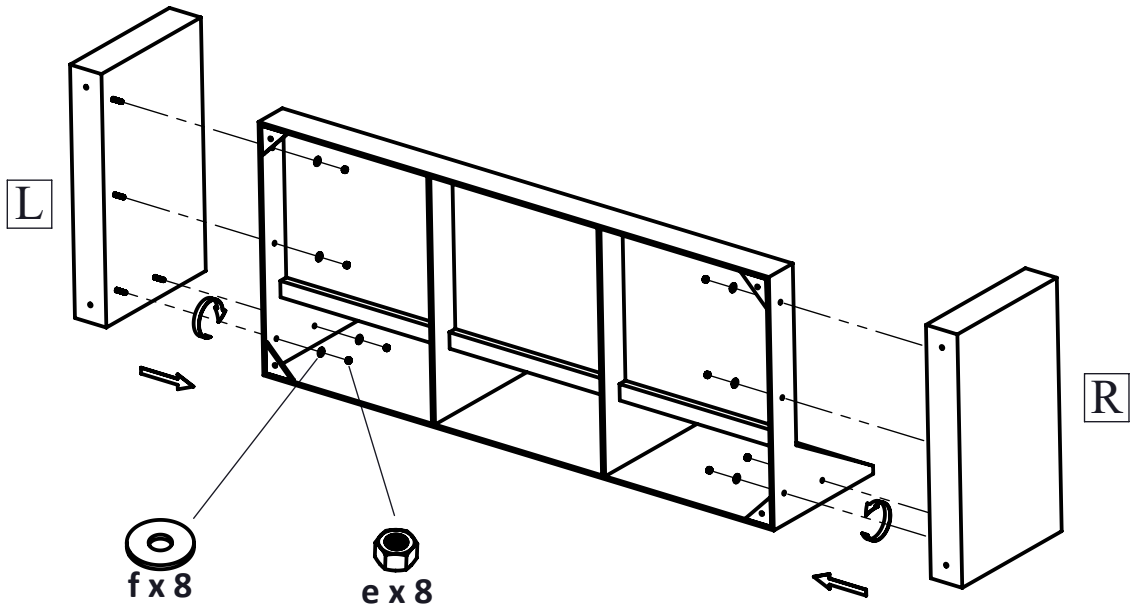

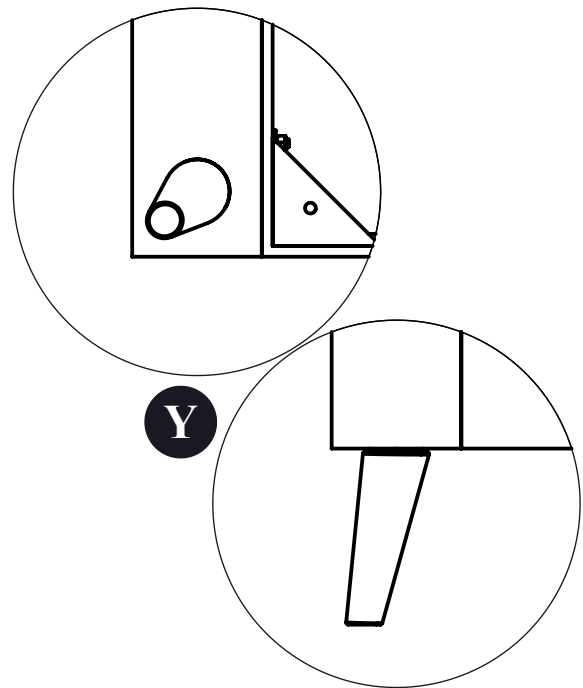
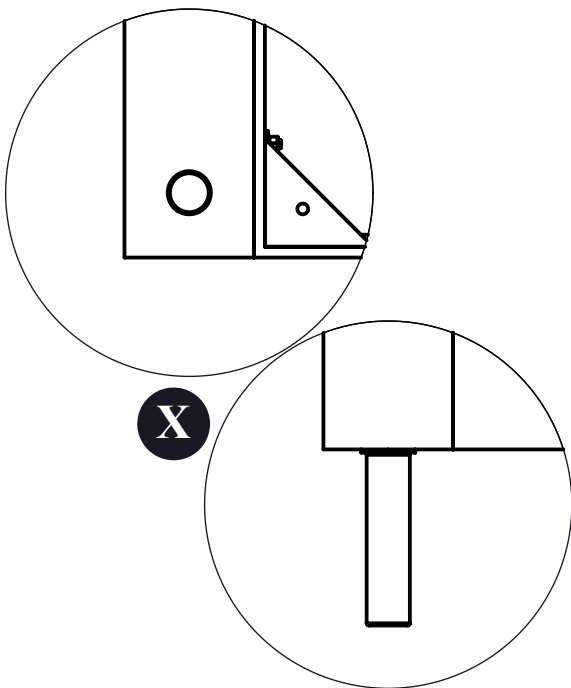
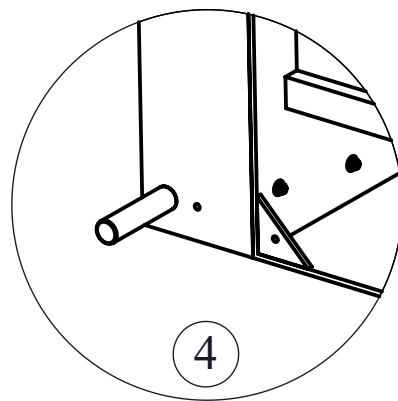
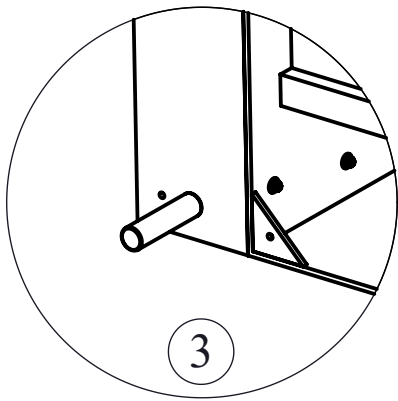
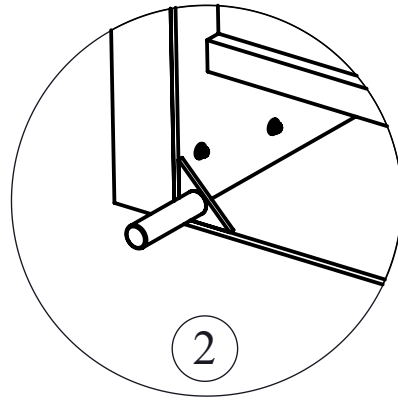
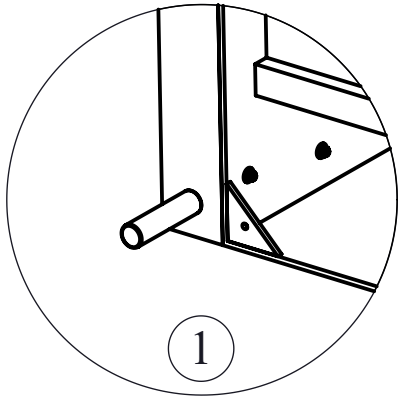

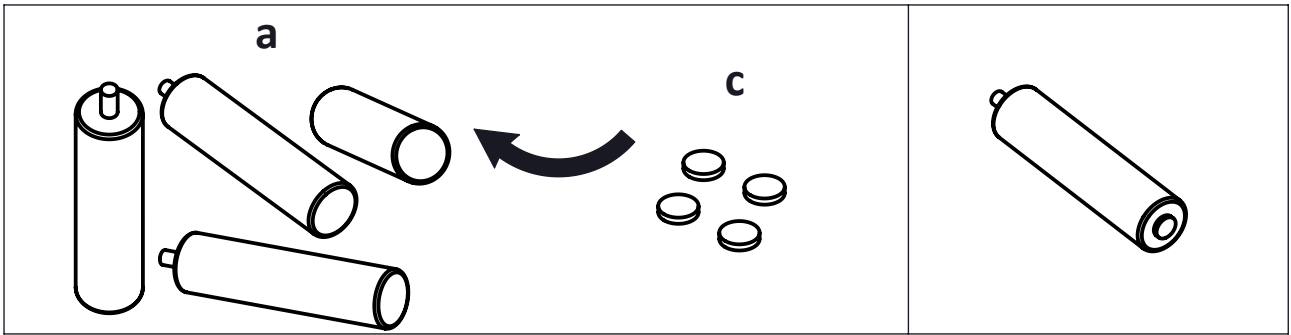

A
B
C

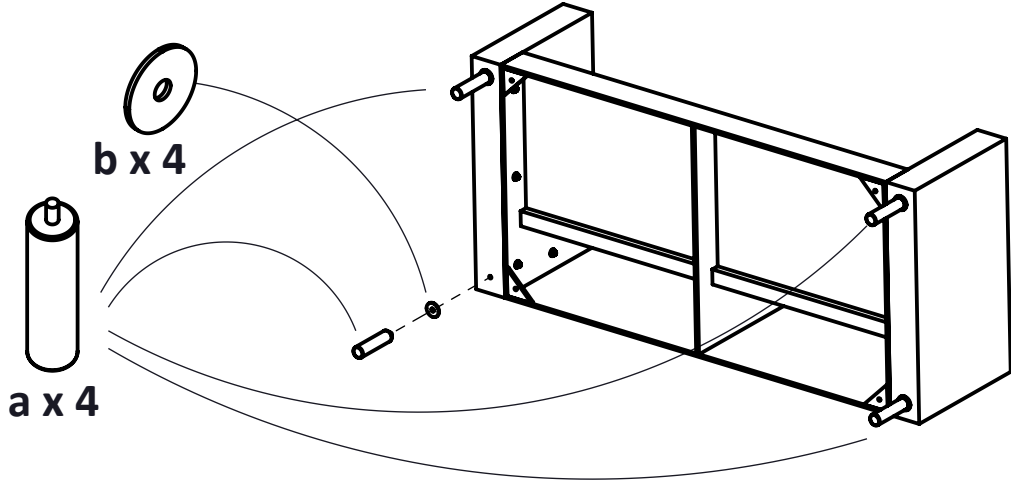

D
E

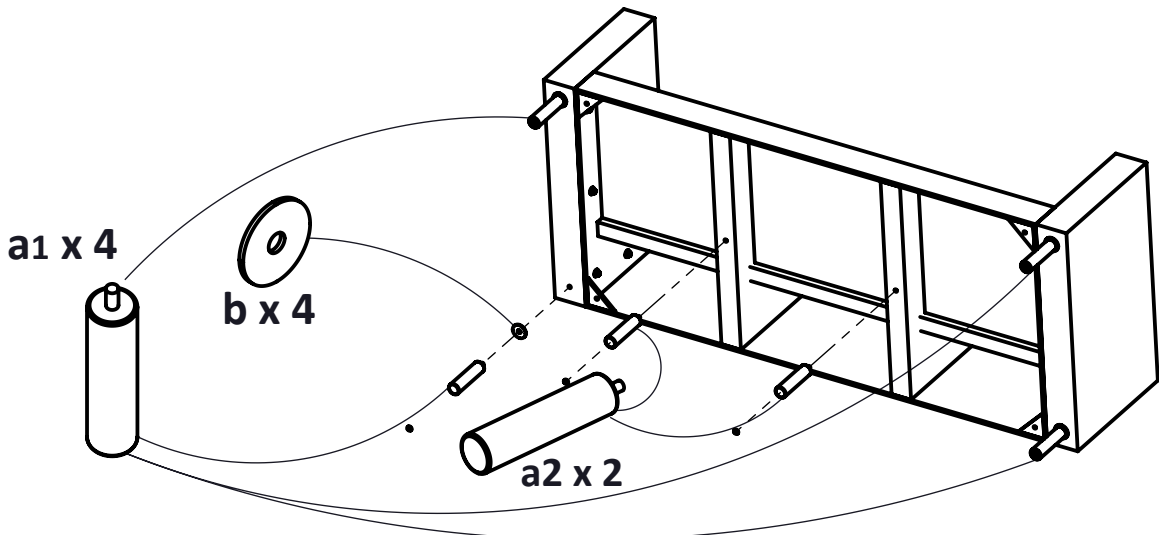
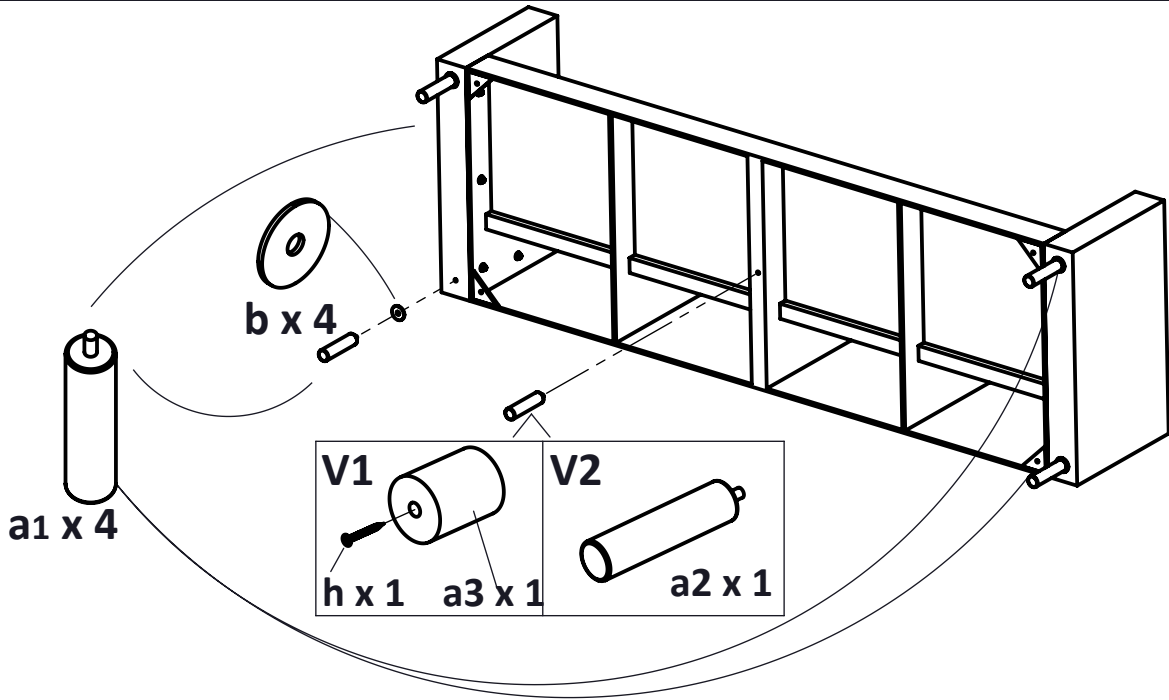

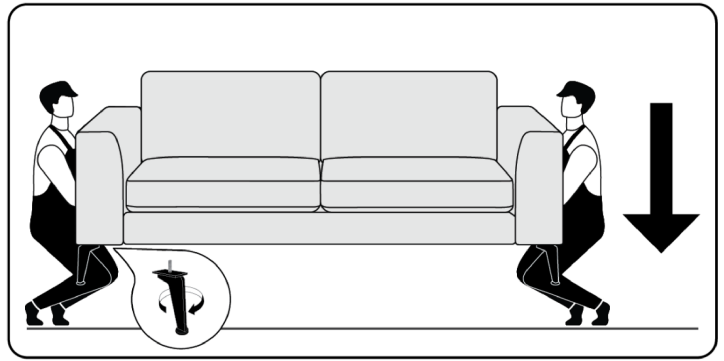

V1

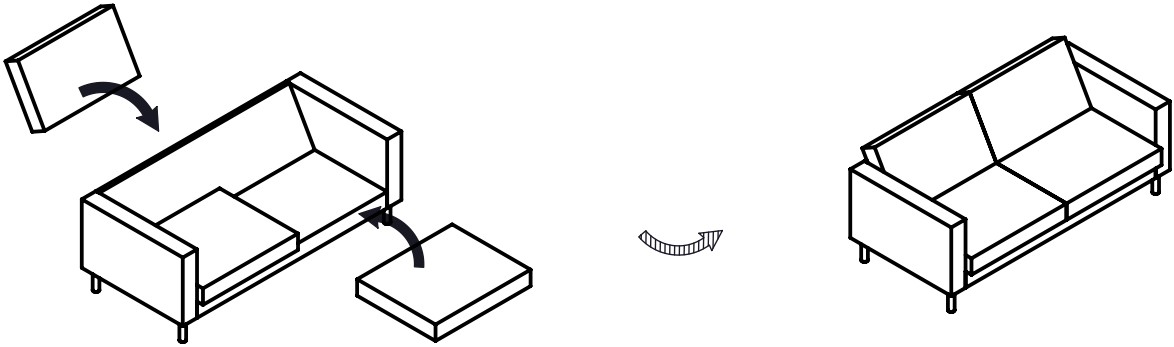

V2

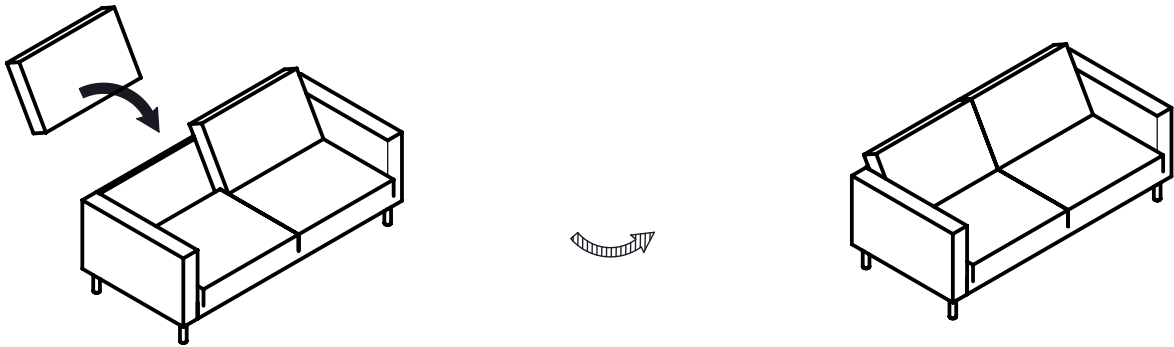

V3

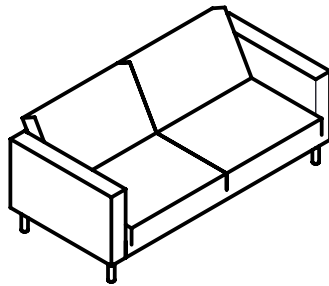

V4

