

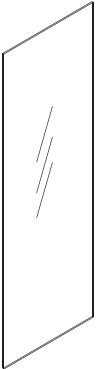

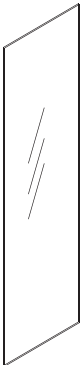

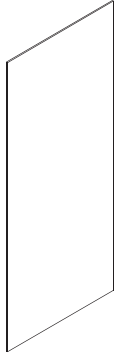





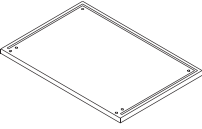

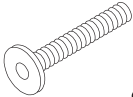

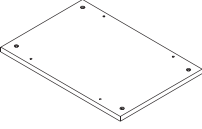

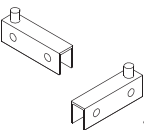
<p>1555x382mm</p>  <p>A 1</p>	<p>1576x345mm</p>  <p>B 2</p>	<p>1576x387mm</p>  <p>C 1</p>	 <p>D 2</p>	 <p>E 4</p>		
<p>UP</p>  <p>F1 1</p>	<p>382x285mm</p>  <p>G 3</p>		 <p>H 4</p>	 <p>I 8</p>	 <p>J 8</p>	
<p>DOWN</p>  <p>F2 1</p>	 <p>K 12</p>	 <p>L 12</p>	 <p>M 2</p>	 <p>N 2</p>	 <p>O 2</p>	 <p>P 4</p>
	 <p>Q 2</p>	 <p>R 1</p>	 <p>S 1</p>	 <p>T 2</p>	 <p>U 1</p>	 <p>V 4</p>

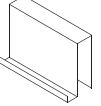
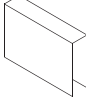

4

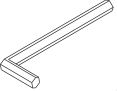

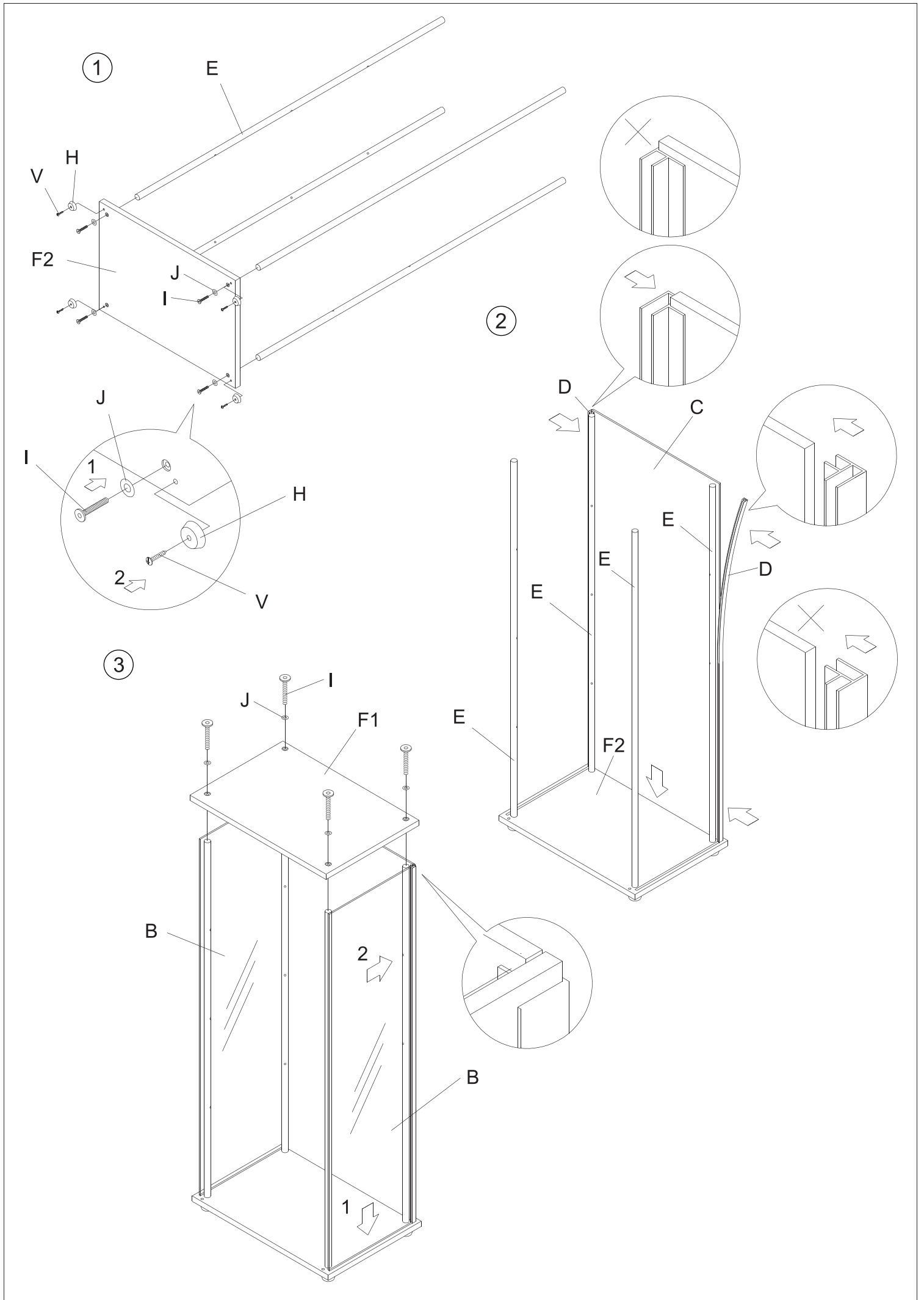
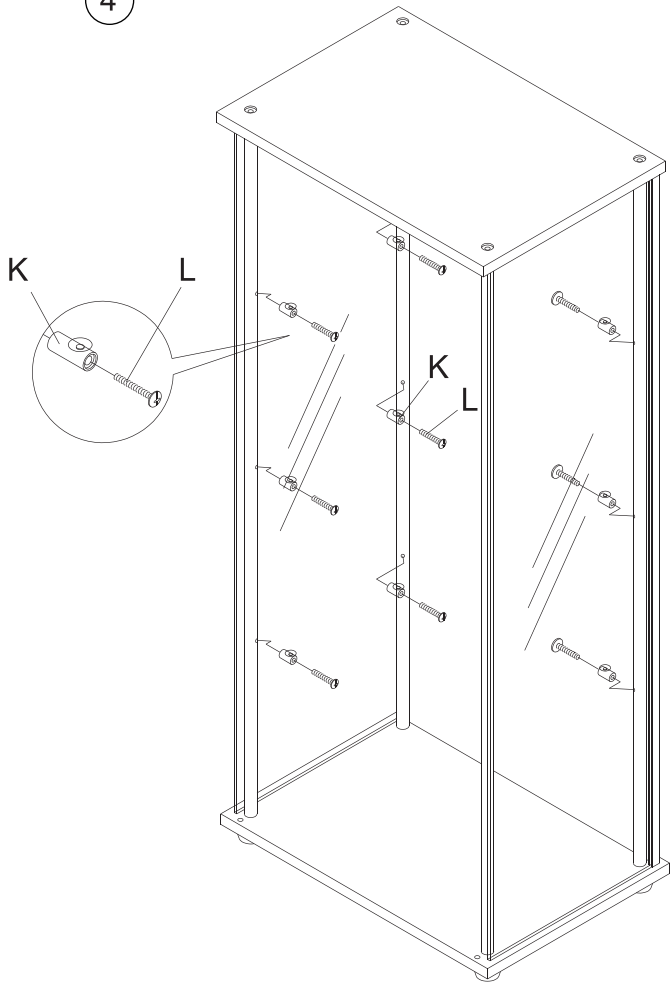
5

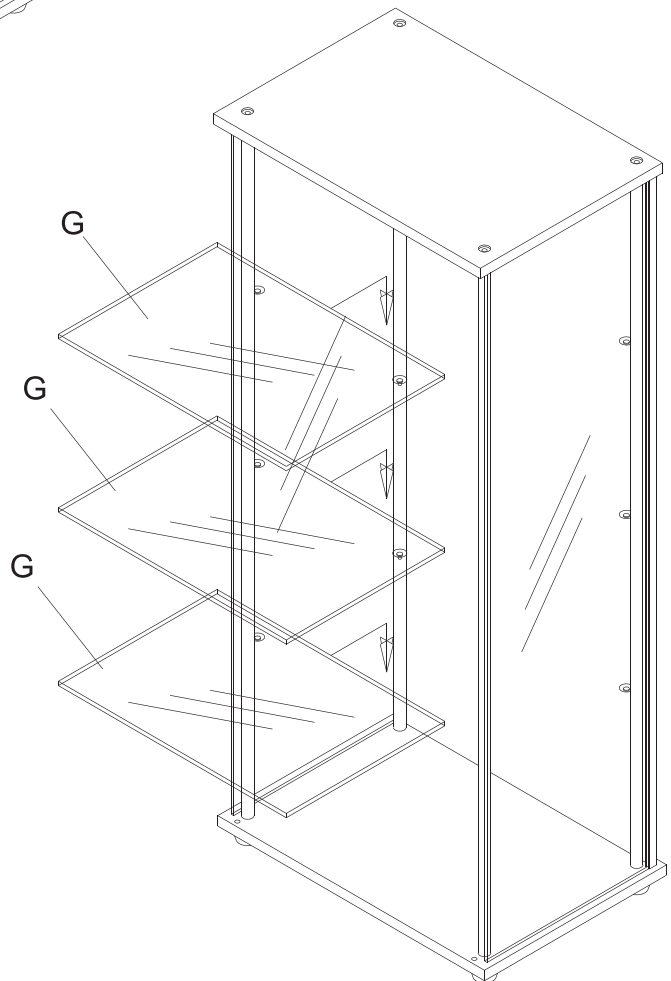

6

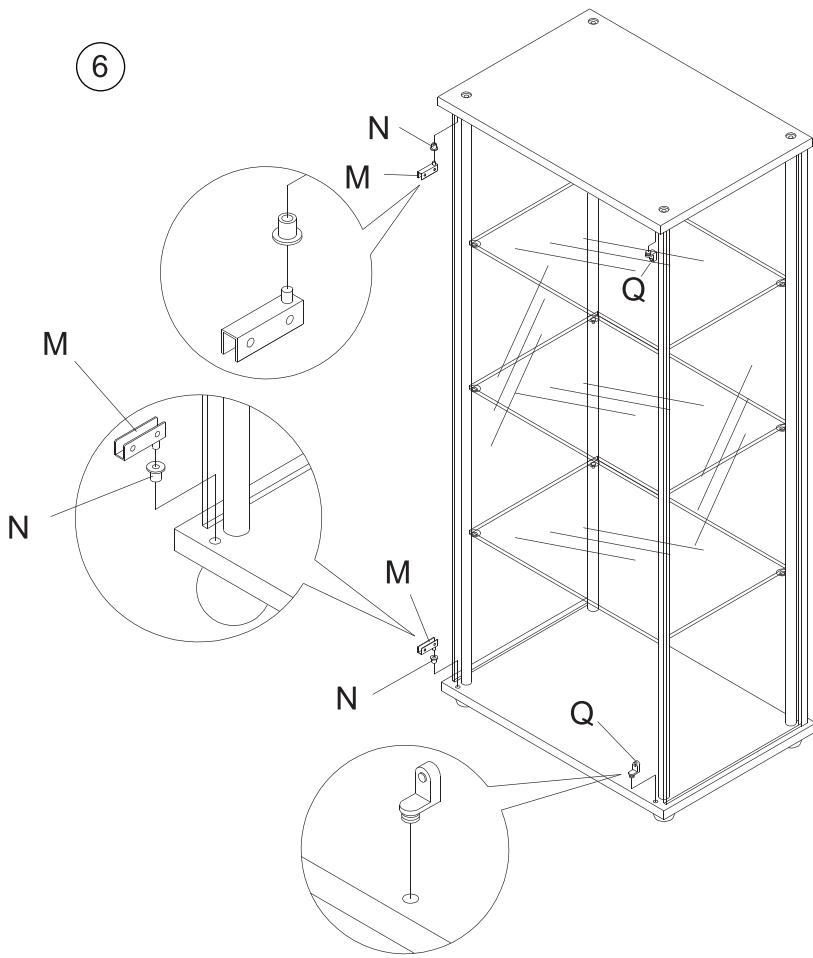

7

