

# KOKKUPANEKUJUHEND

A 1tk	B 1tk	C 2tk	D 1tk	E 1tk	F 3tk	G 8tk	H 1tk	I 32tk

TÄHELEPANU! Jalad ja kinnitustarvikud on pakitud diivani istme alla.

**SAMM 1** Paigaldage istme ja nurgaosa jalad

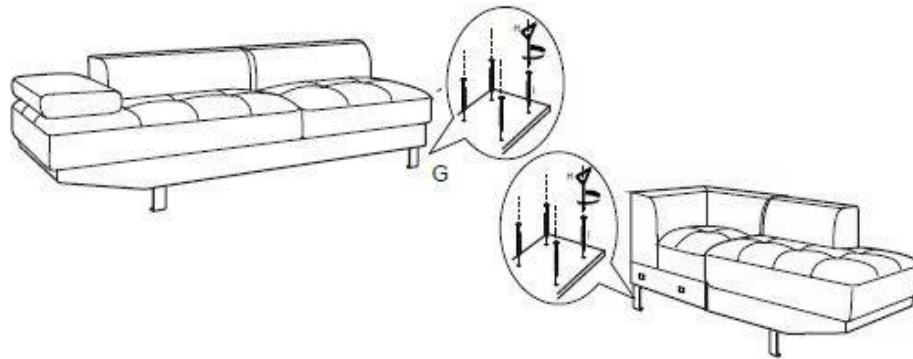

**SAMM 2** Paigaldage peatoed

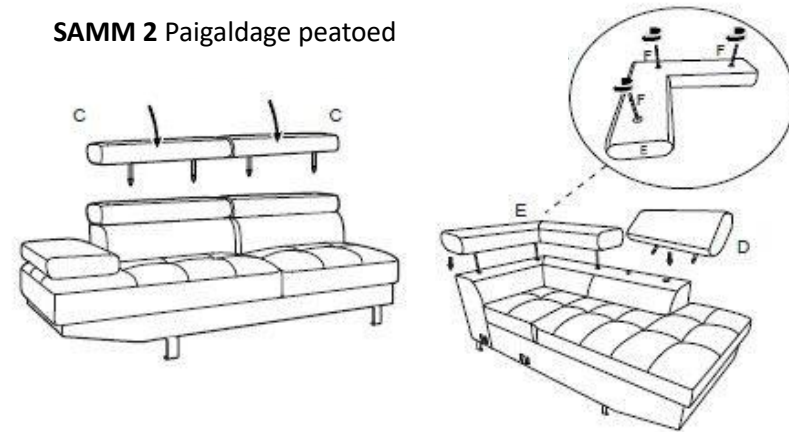



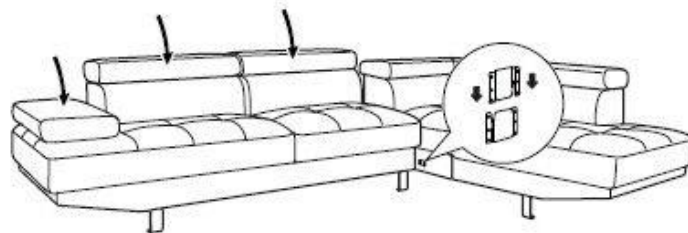



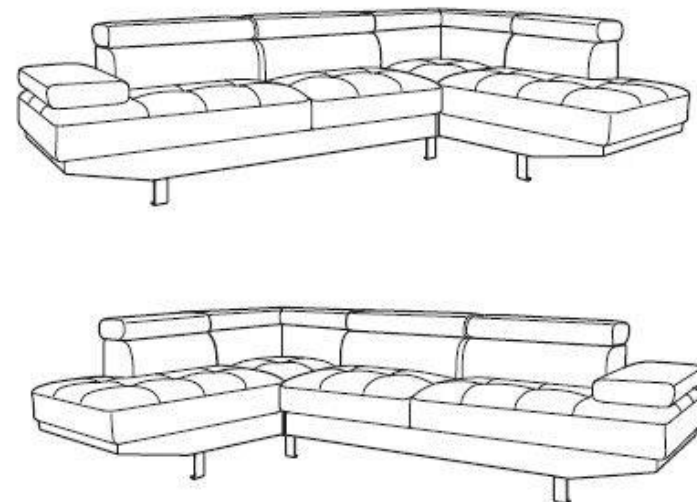

**SAMM 3** Ühendage omavahel iste ja nurgaosa

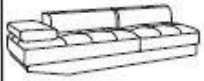

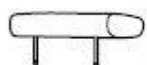
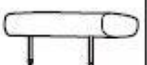
KOKKUPANEKU JÄRJEKORD JA SAMMUD ON SAMAD VASAKU VÕI PAREMA NURGAGA MUDELI PUHUL.



# ASSEMBLY INSTRUCTIONS

A : SOFA 1 PC	B : CHAISE 1 PC	C : HEADREST 2 PCS	D : HEADREST 1 PCS	E : HEADREST 1 PC	F:SCREW 3 PCS	G : LEG 8PCS	H: SCREWDRIVER 1 PC	I : SCREW 32 PCS
								

Please be sure to take out the legs and parts list from inside the box or zip underneath from the sofa.

**Step 1** FIX THE LEG TO LOVESEAT AND CHAISE.

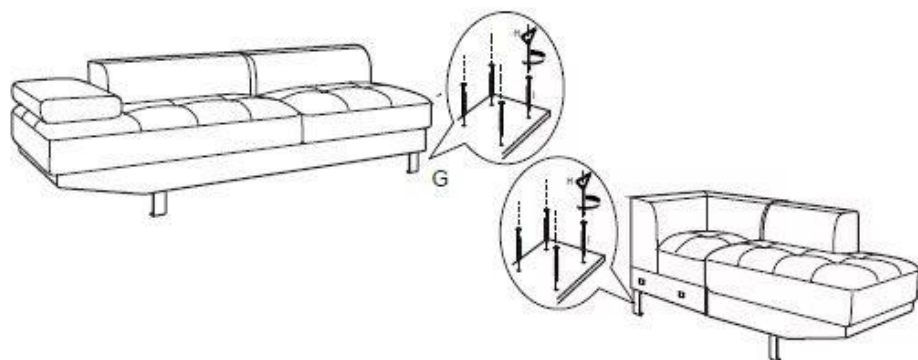

**Step 2** FIX THE HEADREST TO SOFA



**Step 3**

FIX THE SOFA TO THE CHAISE.

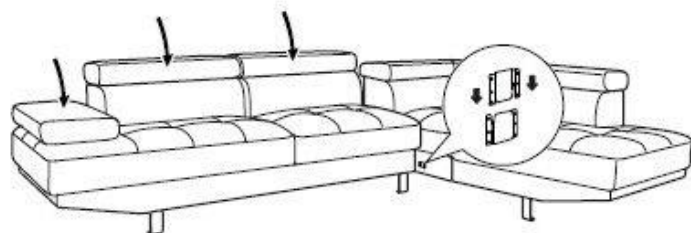

**FINISH**



IT IS THE SAME ASSEMBLY WAY TO ASSEMBLY THE SOFA , WHEN THE CHAISE IS FACING ON THE RIGHT HAND SIDE.