













KOKKUPANEKUJUHEND / ASSEMBLY INSTRUCTION

TÖÖTOOL MERANO / TASK CHAIR MERANO 27710, 27713, 27714, 27719

HOME
4 YOU

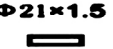
A		ISTME KORPUS 1tk BACK BOX SEAT 1pc
B		MEHHANISM 1tk MECHANISM 1pc
C		PEATUGI 1tk HEAD REST 1tk
D		GAASAMORT 1tk GAS LIFT 1pc
E		RIST 1tk BASE 1pc
F		RATAS 5tk CASTOR 5pcs
H		KRUVI 2tk HAND WHEEL 2pcs
K		KRUVI M6x35mm 2tk SCREW M6x35mm 2pcs
L		KRUVI M6x45mm 2tk SCREW M6x45mm 2pcs
M		KRUVI M6x25mm 2tk SCREW M6x25mm 2pcs
N		VÕTI 1tk ALLEN KEY 1tk
O		SEIB 2tk WASHER 2pcs
P		KRUVIKATE 2tk CAP COVER 2pcs

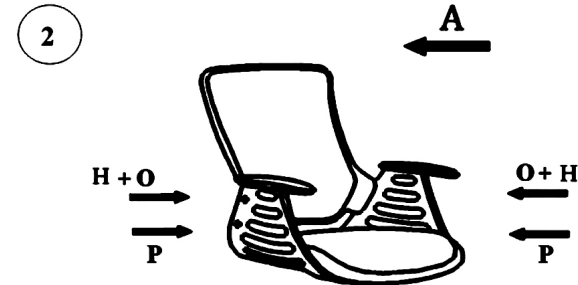
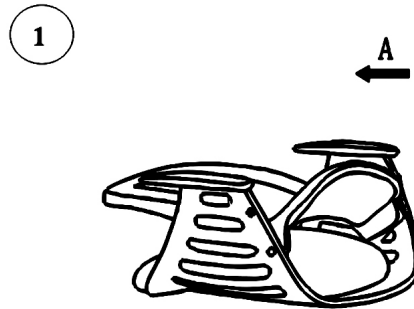

SAMM 2 Tõstke seljatugi üles ja kinnitage mõlemalt poolt korpuse külge kruvidega (H) ja seibidega (O). Katke augud katetega (P).

STEP 2 Bring the backrest upright and attach it to the seat on both sides with knobs (H) and washers (O) then put cap covers (P) on the holes of arms.

SAMM 3 Monteerige mehhanism (B) istmekorpuse (A) põhja alla. Kinnitage kruvidega (K) eest poolt ja kruvidega (L) tagant poolt.

STEP 3 Install the mechanism (B) at the bottom of combo (A) with screws (K) for the front side screw holes and screws (L) for the rear side screw holes.

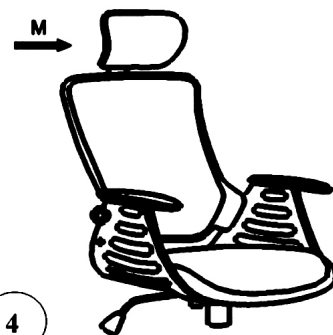
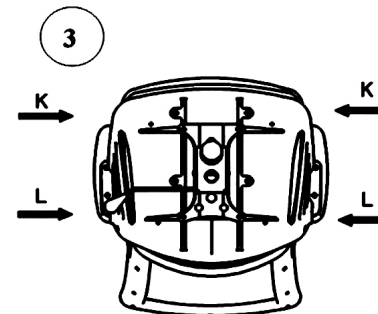

SAMM 4 Kinnitage peatugi (C) seljatoe (A) külge kruvidega (M).

STEP 4 Fix the pillow (C) to the back rest (A) with the screws (M).

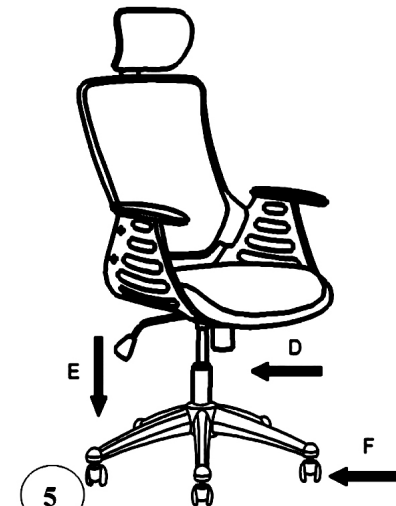

SAMM 5 Paigaldage gaasiamort (D) mehhanismi (B) ja jalaristi (E) vahele. Suruge rattad (F) jalaristi (E) külge.

STEP 5 Insert the gas bar (D) into the mechanism (B) and the castors (F) into the base (E), then combine them.