





 N5	 BX 16	 CX 16	 DX 16	 EX 4	 FX 4	 N4
AX 1						GX 1



X 1



X 1

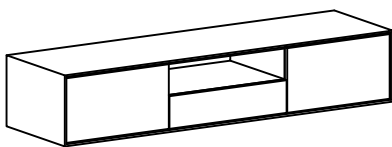
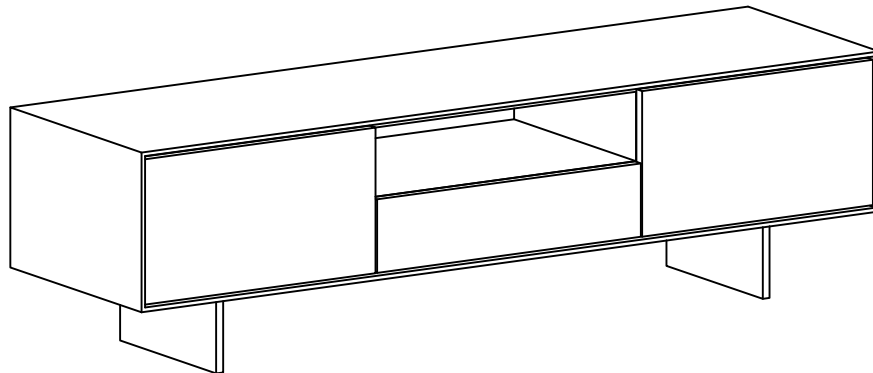

X 2

