



 N5 AX1	 BX8	 CX8
 DX8	 EX4	

1-1



X1

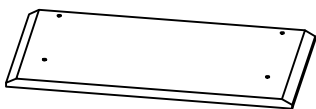
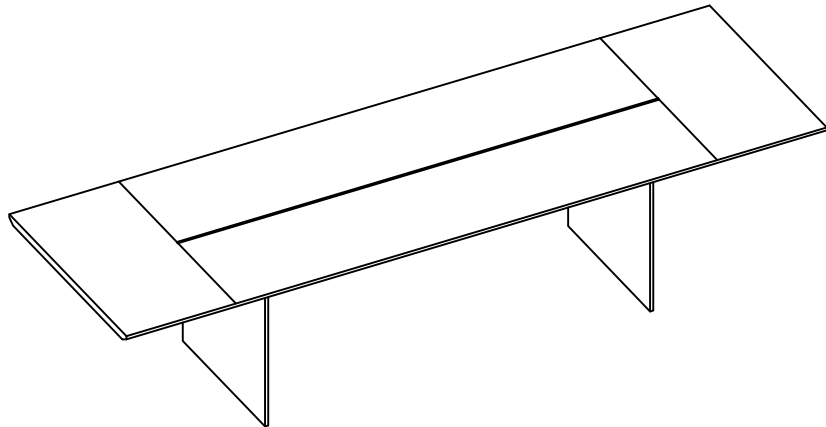
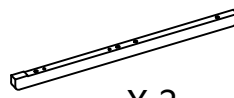

X2

