

















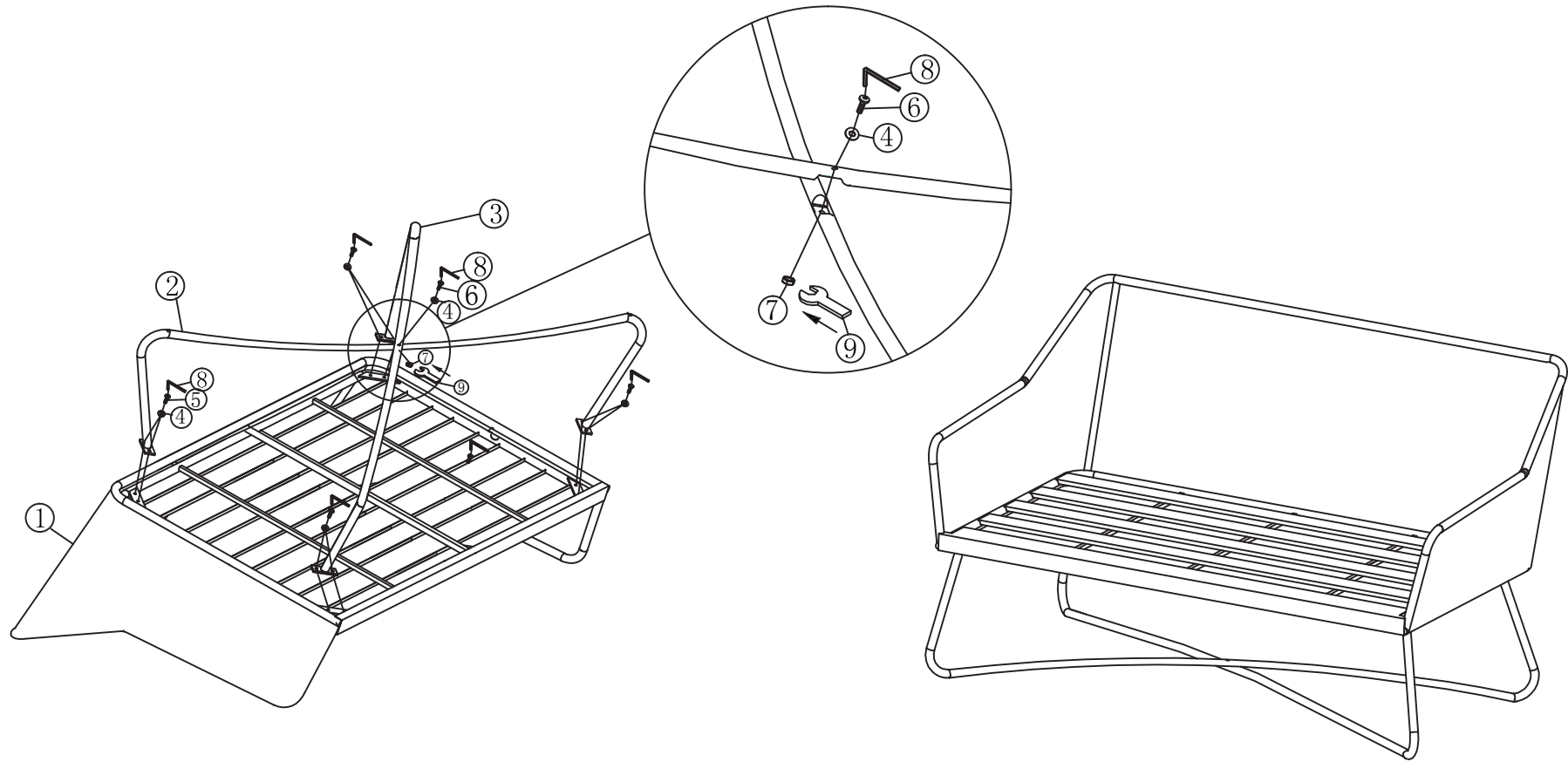









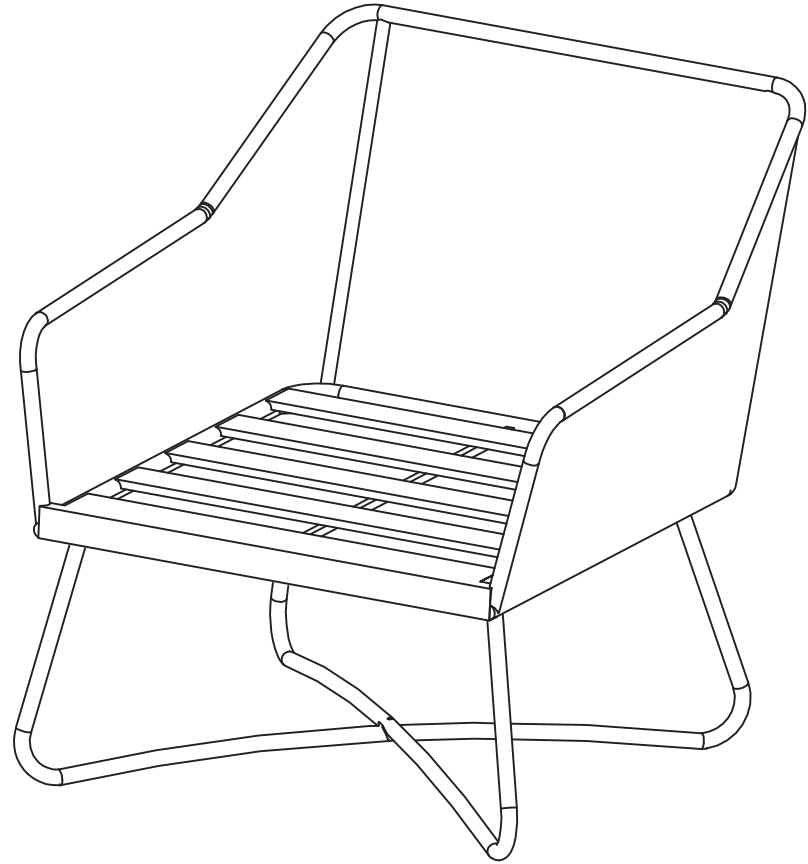
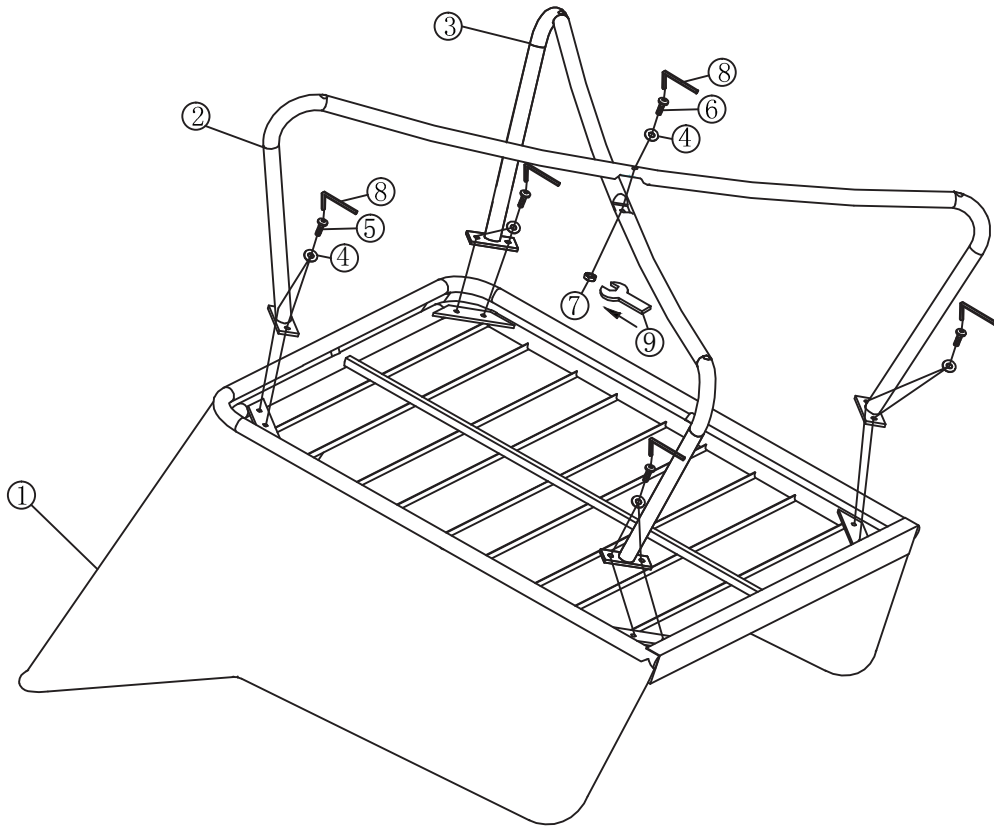

①  1PC	②  1PC	③  1PC	④  9PCS	⑤  M6*15 8PCS
⑥  M6*30 1PC	⑦  1pc	⑧  4mm 1PC	⑨  1PC	



①  1PC	②  1PC	③  1PC	④  9PCS	⑤  M6*15 8PCS
⑥  M6*30 1PC	⑦  1pc	⑧  4mm 1PC	⑨  1PC	



①		1PC	②		1PC	③		1PC	④		8PCS	⑤		M6*15 8PCS
⑥		M6*30 1PC	⑦		1pc	⑧		4mm 1PC	⑨		1PC	⑩		1PC

