

# ASSEMBLY PICTURE

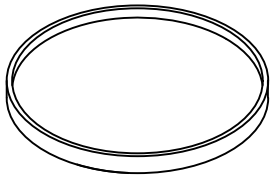

Ax1

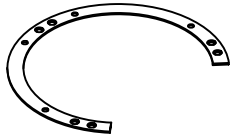

Bx1

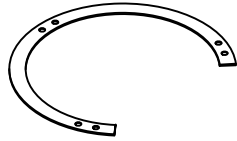

Cx1

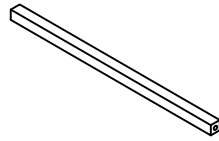

Dx6

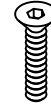

Ex12



Fx4



Gx1

①

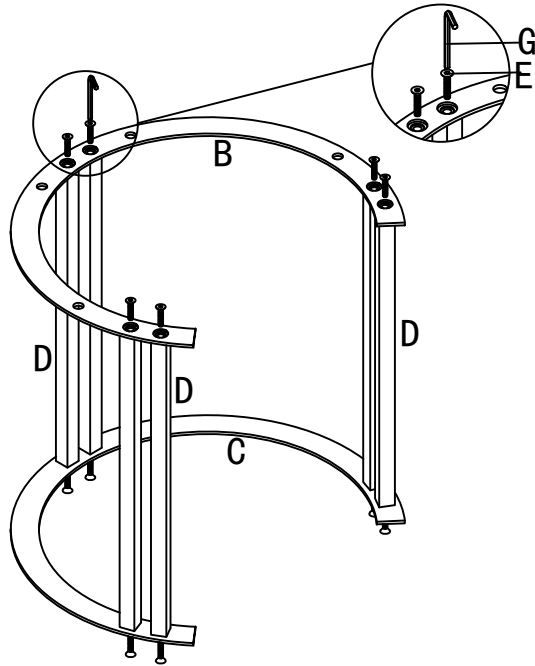

②

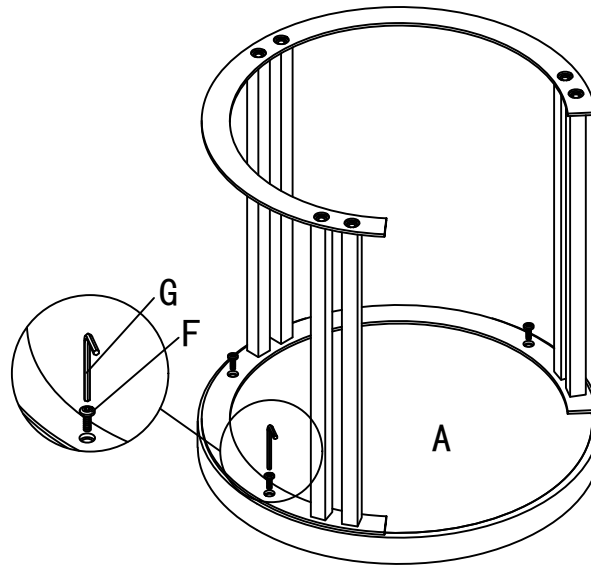

③

