

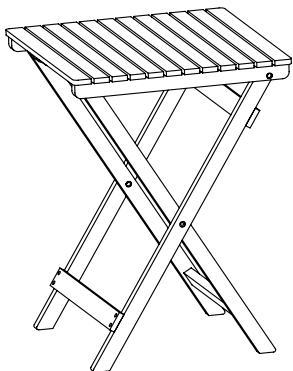



DESCRIPTION



No.	HARDWARE LIST		Q.TY
A		6X50X13	2PCS
B		M6	2PCS
C		6.5x14x1	2PCS
D			1PC

ASSEMBLY INSTRUCTION

STEP1

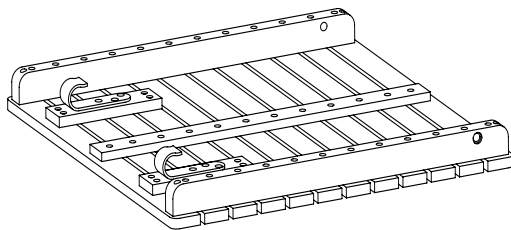

STEP2

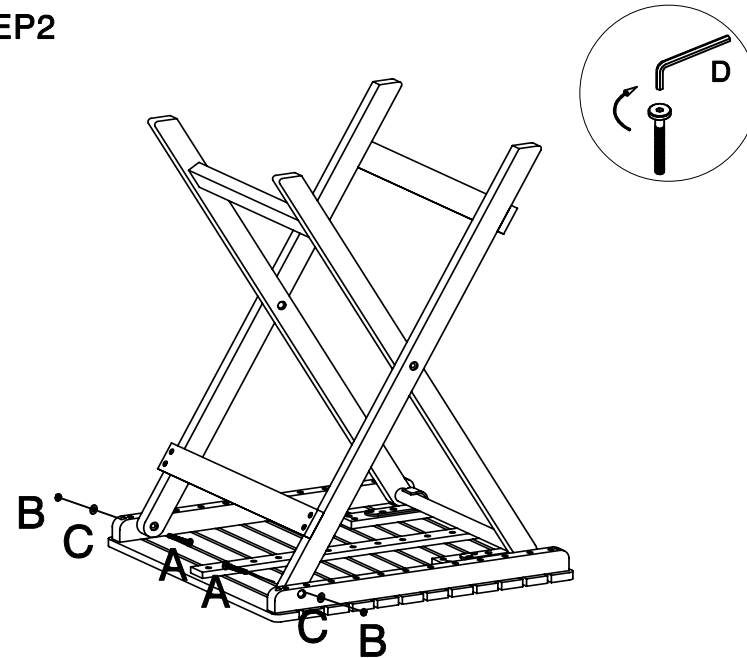

STEP3

