

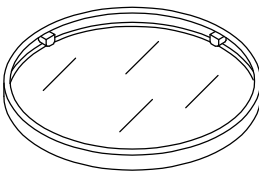

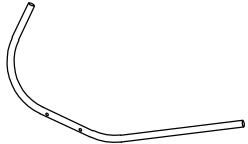



# ASSEMBLY INSTRUCTIONS

							
A x1	B x4	C x2	D x8	E x8	F x8	G x4	H x1

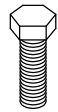
1

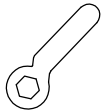
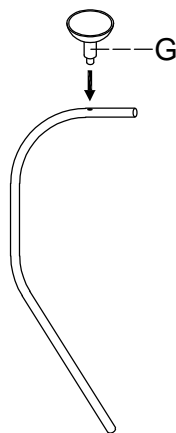

2

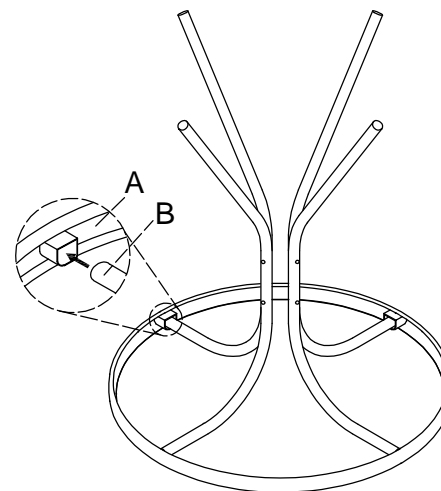

3

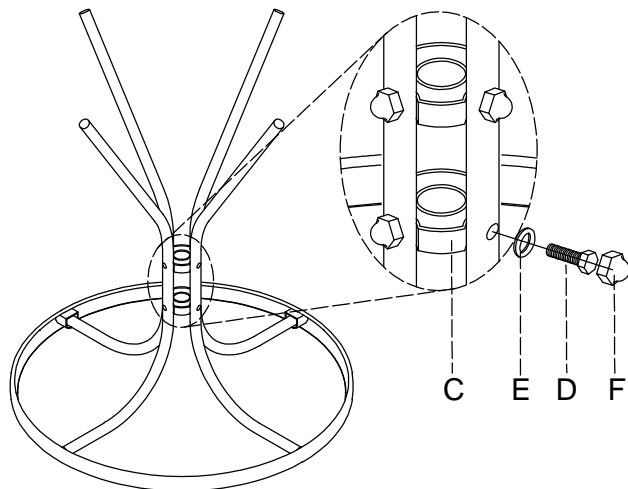

4

