

ASSEMBLY INSTRUCTIONS

DINING CHAIR MODEL#: UDC21093

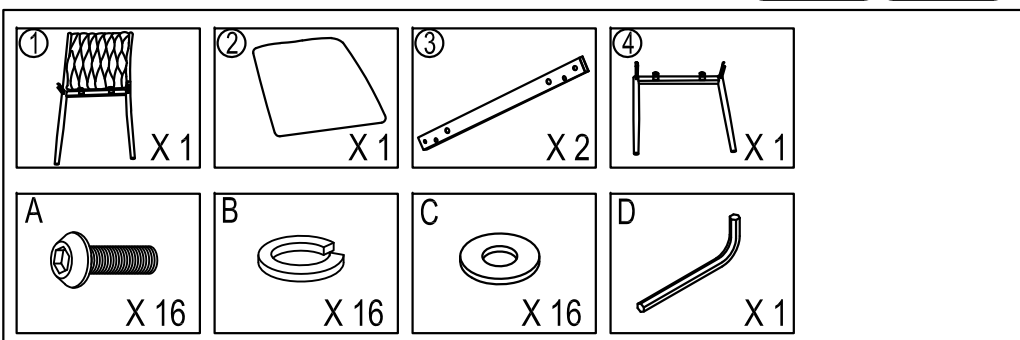

1

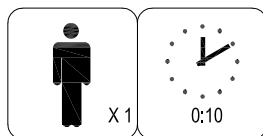
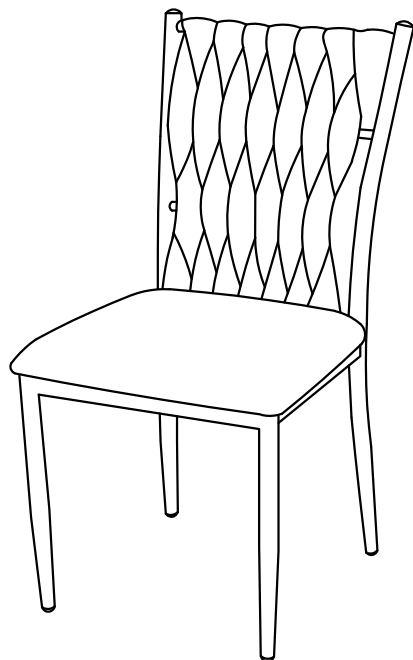
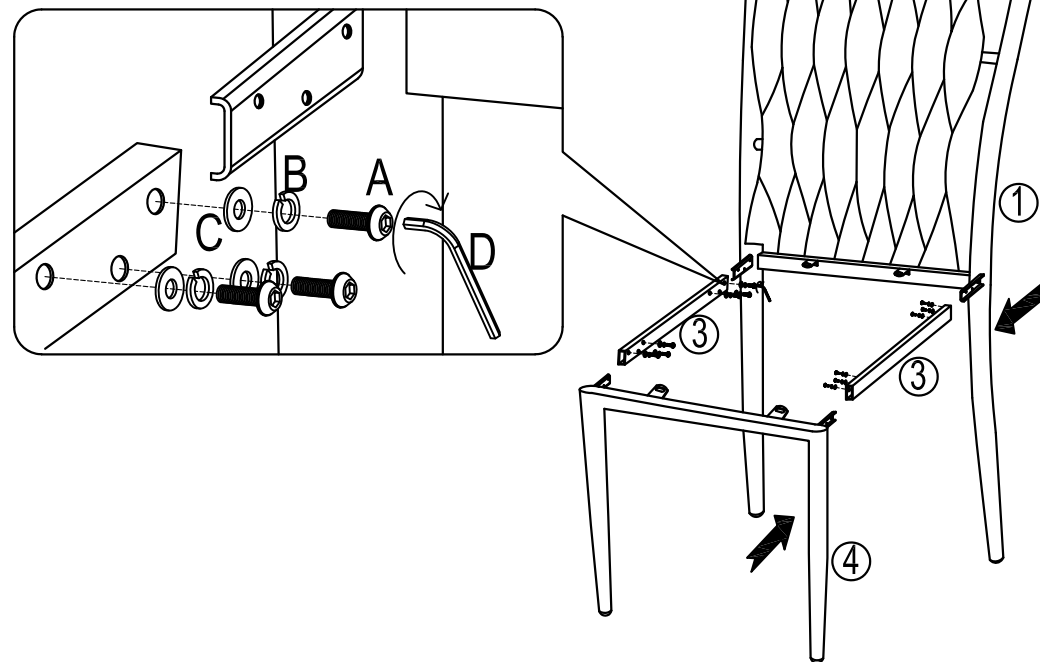

2

