

Assembly

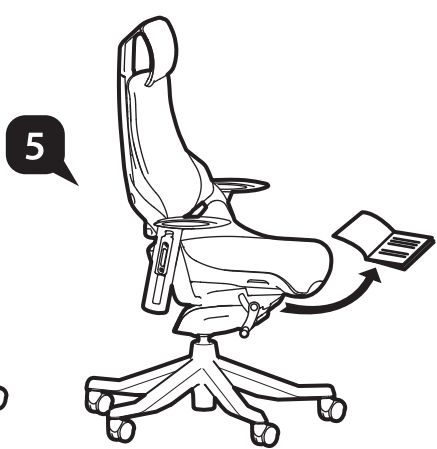

1

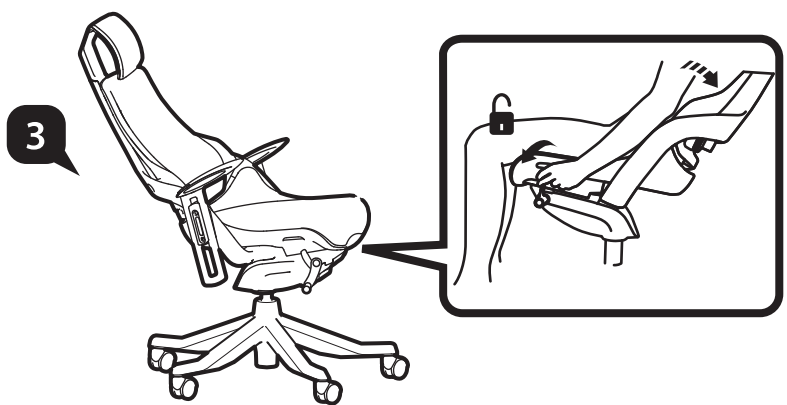
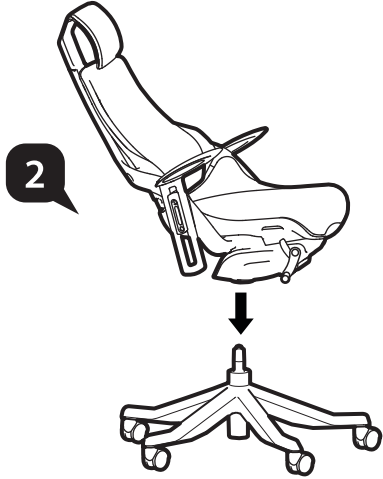
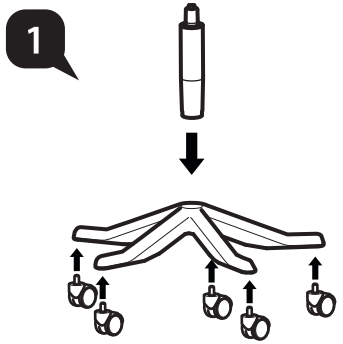
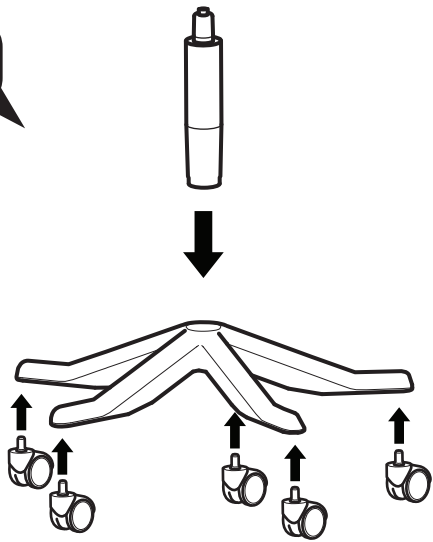

2

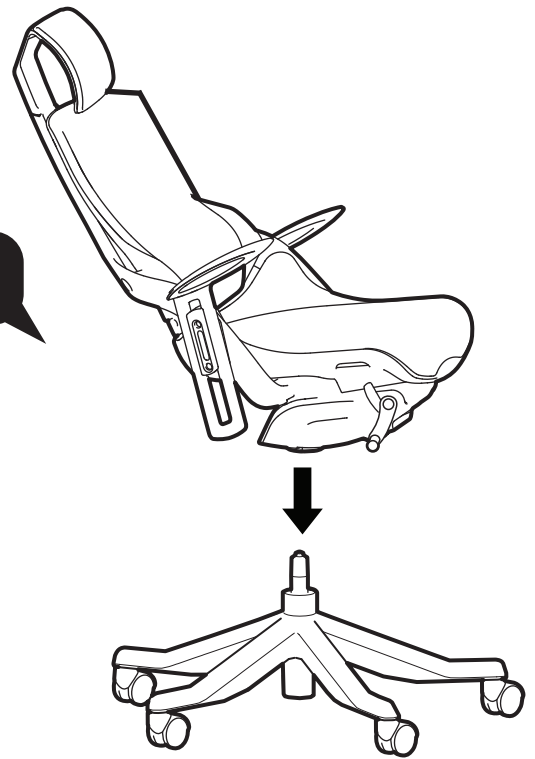

3

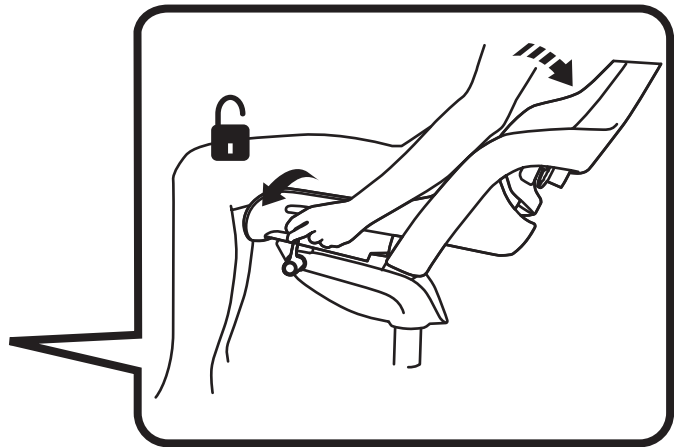
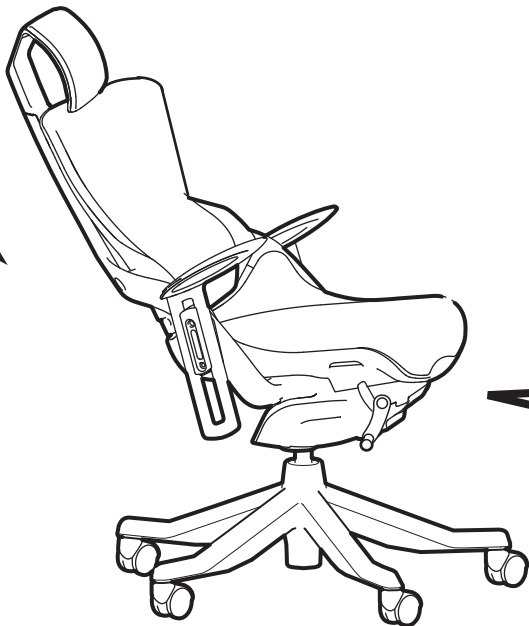

4

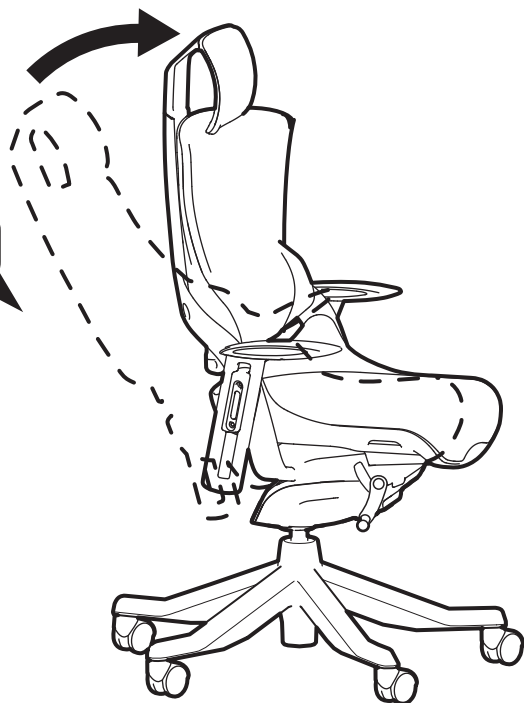

5

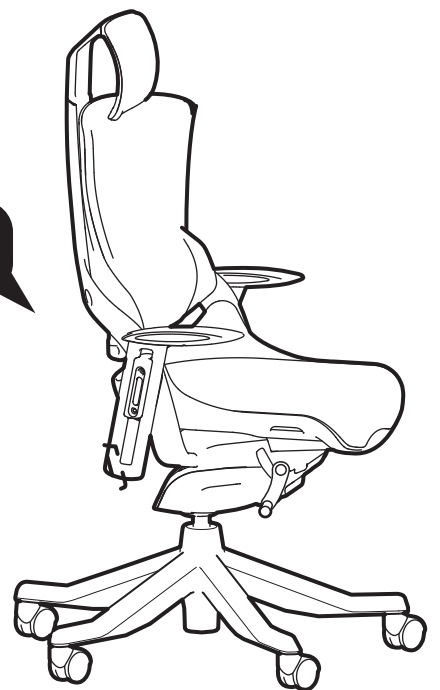

Assembly

1



5

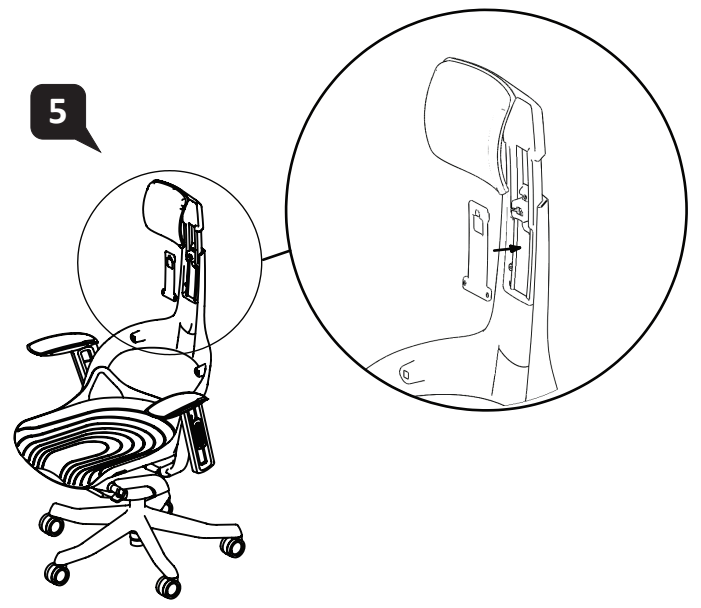

2

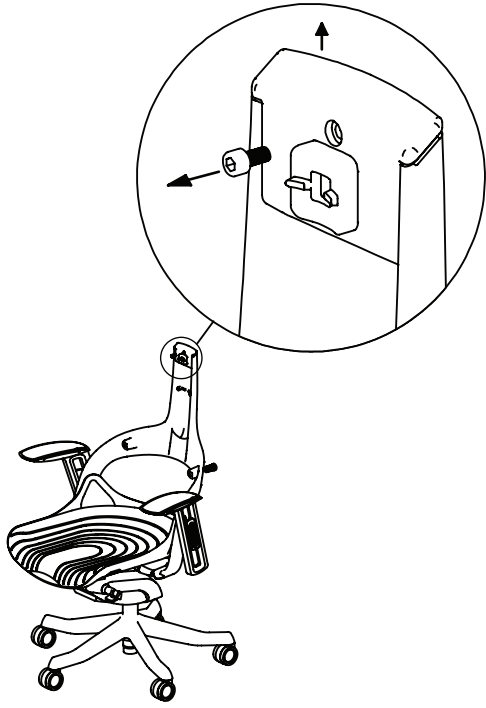

5

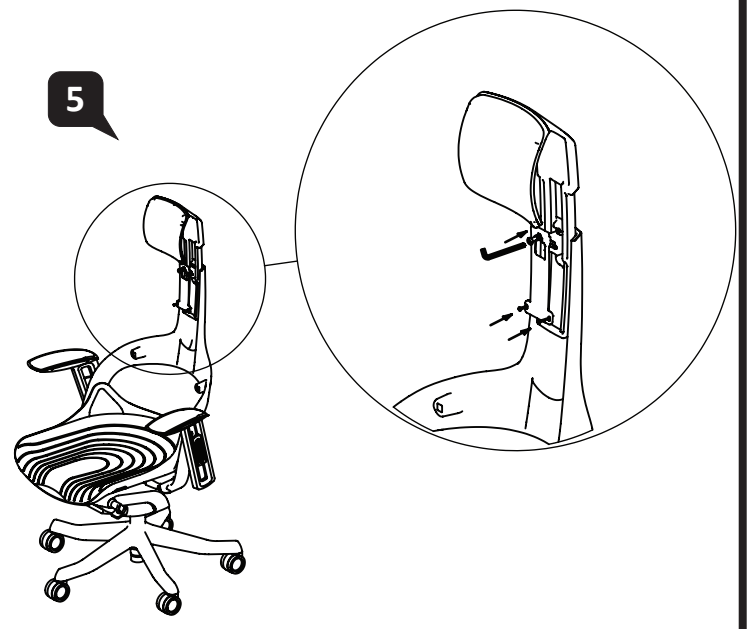

3

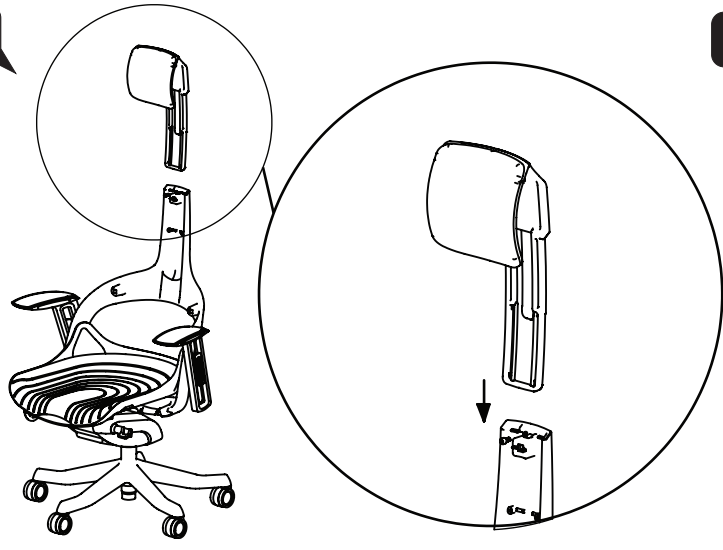

6

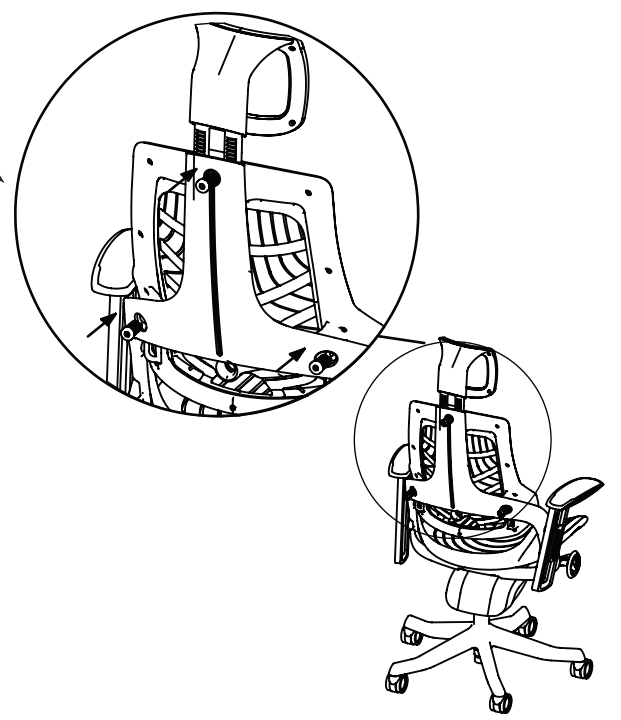

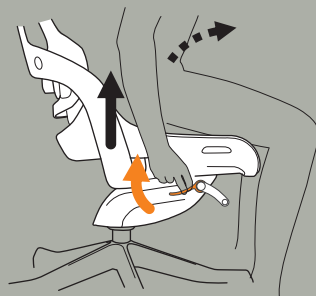
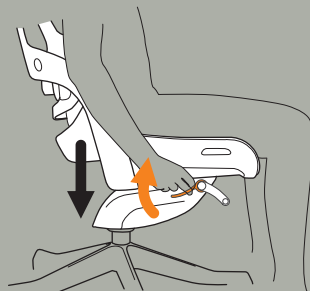

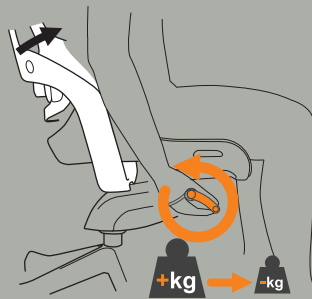
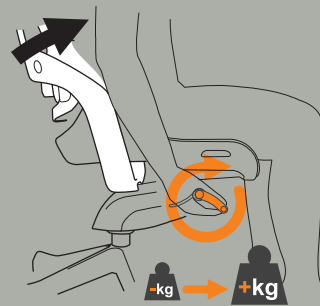

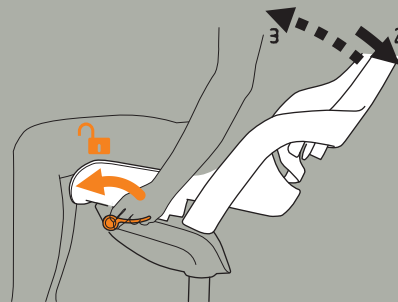
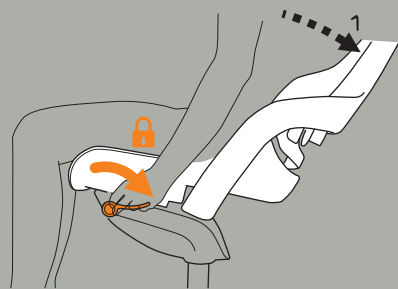

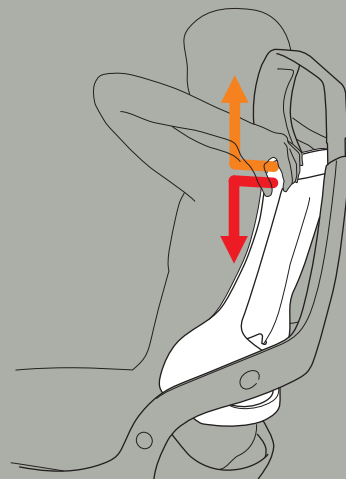

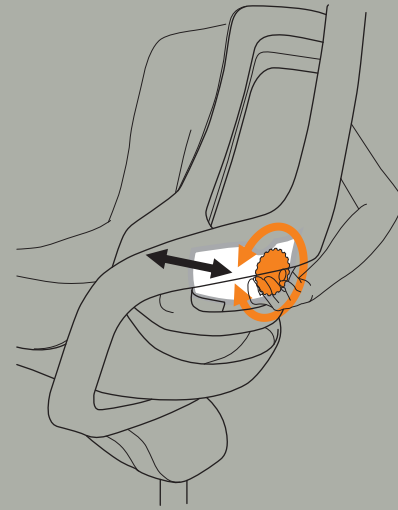

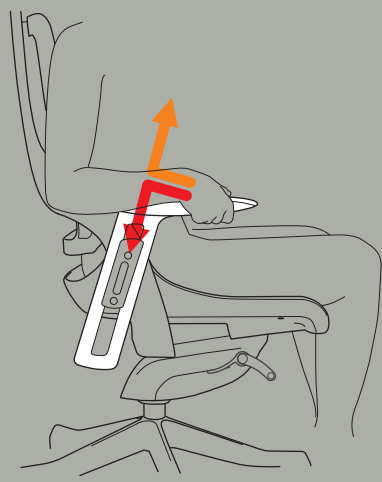



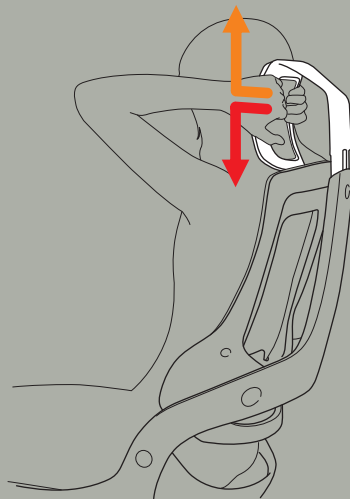

Assembly

